

CLEAN ENERGY COUNCIL INSTALL AND SUPERVISE GUIDELINES FOR ACCREDITED INSTALLERS

VERSION 13, APRIL 2019

IMPORTANT INFORMATION ON AS/NZS 5033:2021

Standards Australia published AS/NZS 5033:2021 – *Installation and safety requirements for photovoltaic (PV) arrays* on Friday 19 November 2021.

With the release of AS/NZS 5033:2021, sections of these Guidelines have been superseded as they have specific references to AS/NZS 5033:2014.

In most states and territories, there will be a transition period of six (6) months where installers can choose to follow the old or new version of the standard. However, installers should be aware of the following important information:

- Installers that are installing to the 2014 version of the standard must follow all sections of Version 13 of the CEC Guidelines.
- Installers that choose to follow the new 2021 version of the standard must still follow Version 13 of the CEC Guidelines, unless the clause has been superseded by the newer standard.
- This is also the case for the references to AS/NZS 1170.2 and AS/NZS 3000:2018 (to allow for amendments).

Installers must also comply with either the old or new version of the standard for the entire installation. You cannot choose sections from different versions of the standard for an installation.

TABLE OF CONTENTS

1	GENERAL	5
2	DEFINITIONS	5
3	STANDARDS FOR INSTALLATION	6
4	LICENSING	7
4.1	Extra low voltage (ELV)	7
4.2	Low voltage (LV)	7
4.3	Workplace Health and Safety (WH&S)	7
5	DOCUMENTATION	8
6	RESPONSIBILITIES OF ACCREDITED PERSON	9
6.1	Signing Off as an Accredited Person	9
6.2	Limits apply to the number of installations an accredited person shall sign-off per day	9
6.3	Multiple systems at one location	10
6.4	Grid connect battery backup system	10
7	PV ARRAY INSTALLATION	11
7.1	General	11
7.2	Roof mounting (not building integrated)	11
7.3	Free standing PV arrays	12
7.4	Building integrated (BIPV) installations	13
7.5	Verification of AS/NZS1170.2	13
7.6	Attaching modules to array mounting structure	13
7.7	Earthing of array frames for a PV array with maximum voltage greater than ELV (including AC modules and micro inverter systems)	14
7.8	Wiring at the PV array	16
7.9	AC and DC PV array isolators	17
7.10	DC PV array isolators	17

8	DC ISOLATOR AND STRING PROTECTION	19
8.1	Selecting DC isolation devices	19
8.2	Sizing DC Isolation devices	22
8.3	Installing DC Isolation devices	24
8.4	String protection	26
9	PV ARRAY CABLE BETWEEN ARRAY AND INVERTER	26
10	INVERTER INSTALLATION	28
10.2	PV array DC isolator near inverter (not applicable for micro inverter AC and modules systems)	29
10.3	AC isolator near inverter	30
10.4	AC Isolators for micro inverter installation	31
10.5	AC cable selection	31
10.6	Main switch inverter supply in switchboard	32
10.7	Shutdown procedure	33
10.8	Additional requirements for micro inverters	34
10.9	Inverter earth fault indication	34
11	METERING	35
12	SIGNAGE	35
13	COMMISSIONING	35
14	INSTALLATION AND COMMISSIONING	36
14.1	General	36
14.2	Insulation resistance measurement	36
14.3	String inverter installation and commissioning sample	37
14.4	Micro inverter and AC module installation and commissioning sample	39

15	EXAMPLES OF SIGNAGE	41
15.1	String inverter systems	41
15.2	Micro inverter systems	42
15.3	Example of 1 X string, 1 X inverter IES connected to sub board	43
15.4	Example of 1 X inverter, 2 X arrays IES connected to main board	44
15.5	Example of 2 X string inverters IES connected to marshalling board	45
15.6	Example of Micro inverters connected to main board	46
16	ATTACHMENT 1: DANGEROUS SITUATION	47
17	ATTACHMENT 2: PV ARRAY ROOF MOUNTING	47
18	ATTACHMENT 3: WH&S INFORMATION	48

These Guidelines have been developed by Clean Energy Council. They represent latest industry best practice for the installation of grid-connected PV systems. © Copyright 2019

While all care has been taken to ensure these Guidelines are free from omission and error, no responsibility can be taken for the use of this information in the installation of any grid-connected power system.

1 GENERAL

The objectives of these Guidelines are to:

- improve the safety, performance and reliability of solar photovoltaic power systems installed in the field
- encourage industry best practice for all design and installation work involving solar photovoltaic power systems
- provide a network of competent solar photovoltaic power systems designers and installers
- increase the uptake of solar photovoltaic power systems by giving system owners increased confidence in the design and installation work.

The performance of a reliable installation that fulfils system owner expectations requires both careful design and correct installation practice. Compliance with relevant state health and safety regulations is also necessary.

NOTE: These Guidelines alone do not constitute a fully definitive set of rules and are to be read in conjunction with all relevant Australian Standards. Where these Guidelines have additional requirements above those stated in the Australian Standards then these Guidelines shall be followed.

This Guideline was published on 15 April 2019 and will become mandatory on 1 July 2019.

About your accreditation.

Central to the Clean Energy Council's (CEC) work with solar photovoltaic (PV) designers and installers is an accreditation program we often refer to as the Solar Accreditation Scheme.

Depending on the type of accreditation held, CEC accreditation demonstrates an Accredited Person's competence in the design and/or installation of:

- grid-connected solar PV systems
- stand-alone solar PV systems
- grid-connected battery storage

Being an Accredited Person with the CEC makes you eligible to participate in government incentive schemes like the Small-Scale Renewable Energy Scheme (SRES) and others. Part of the CEC's roll is to foster and help grow the renewable energy industry in Australia. It can only continue to grow if we maintain a high standard of quality and of personal, public and electrical safety.

Every Accredited Person has their part to play. After becoming accredited with the CEC, an Accredited Person is required to only work within the scope of the accreditation held by the Accredited Person as outlined in the CEC's Terms and Conditions.

An Accredited Person must follow all requirements in the relevant Australian Standards and Clean Energy Council Guidelines. Where a CEC Accredited Person is found not to comply with all the relevant Australian Standards and CEC Guidelines, the Accredited Person will be required to complete the CEC compliance process where they could be issued with demerit points, asked to perform rectification work, asked to prove their competency and even have their accreditation suspended or cancelled.

Beyond compliance, installers are also required to stay up to date with changes in the industry by completing continual professional development (CPD) every year.

A copy of the CEC's Terms and Conditions, Compliance Process and CPD information can be found online at <https://www.solaraccreditation.com.au/installers/compliance-and-standards.html>

2 DEFINITIONS

This document uses the same terminology as outlined in AS/NZS 5033:2014 including amendments 1 and 2. Two important definitions are:

- 2.1.1 **Shall:** Where the word “shall” is used, this indicates that a statement is mandatory.
- 2.1.2 **Should:** Where the word “should” is used, this indicates that a statement is a recommendation.

3 STANDARDS FOR INSTALLATION

Accredited installers shall comply with the current versions of the following standards:

AS/NZS 3000:2018	Wiring rules
AS/NZS 5033:2014 (amdt 1&2)	Installation and safety requirements for photovoltaic (PV) arrays
AS/NZS 4509.2:2012	Stand-alone power systems – Design
AS/NZS 1170.2:2011	Structural design actions – Wind actions
AS/NZS 4777.1:2016	Grid connection of energy systems via inverters – Installation requirements
AS/NZS 1768:2007	Lightning protection
AS/NZS 3008.1.1:2017	Electrical installations – Selection of cables

- 3.1.1 The grid-interactive inverter shall be tested in accordance with AS/NZS 4777.2:2015 and with IEC 62109 (parts 1 and 2).
- 3.1.2 The grid-interactive inverter shall be listed on the Clean Energy Council’s approved inverter list (or approved by the distribution network service provider (DNSP)).
- 3.1.3 The system shall comply with the relevant electrical service and installation rules for the state or territory where the system is installed. The Network Service Provider (NSPs) may have additional requirements. CEC accredited installers shall also follow requirements set out by the NSP of the grid they are connecting to, including provision of documentation to enable connection to the grid.

NOTE: Some examples of extra NSP requirements may include:

- following the connection process;
- adjusting the settings of inverters; or
- registering equipment installed on site.

- 3.1.4 These Guidelines may set additional requirements to the standards. An Accredited Person is expected to follow these Guidelines in addition to the requirements within the relevant Standards. Section 3.1.3 shall be followed by accredited installers at all times.

4 LICENSING

4.1 Extra low voltage (ELV)

All extra low voltage (ELV) wiring should be performed by a 'competent' person, which is defined by Australian Standard AS/NZS4509.1:2009 – Stand-alone Power Systems as: "A person who has acquired through training, qualifications, experience, or a combination of these, knowledge and skill enabling that person to correctly perform the task required."

4.2 Low voltage (LV)

4.2.1 All low voltage (LV) work: >120V DC or >50V AC shall be performed by a licensed electrician.

4.2.2 A licensed electrician is required to be responsible for the safety of the system wiring prior to connection of the system to the grid.

4.2.3 If the system contains ELV wiring installed by a non-licensed person, then a minimum level of inspection by the electrician prior to closing the PV array isolators would include:

- An open circuit voltage test on each PV string and on the total array; and
- A visual inspection of an open PV junction box (randomly selected) and the master array junction box.

These inspections/checks shall confirm:

- the array voltages are as designed and specified; and
- the appropriate cables (cross sectional area and insulation), junction fittings and enclosures have been used.

4.3 Workplace Health and Safety (WH&S)

The CEC is not a safety regulator and cannot provide advice on high-risk work such as:

- working at heights where a person has a risk of falling more than two metres; and
- on or near energised electrical installations or services.

Across Australia, each State and Territory has different definitions, requirements and obligations relating to WH&S. If you are unsure or need assistance, please contact your state or territory work health and safety authority.

More information can be found in Attachment 3.

As a minimum, employers, such as Registered Electrical Contractors (REC), Primary Contractors, Main sub-contractors, Sole Traders, must, so far as is reasonably practicable, provide and maintain a working environment for their employees that is safe and without risks to health.

Employees should be inducted into a well-developed safety management plan. A risk assessment process needs to be followed for each task at the start of each day and before any task change.

A safe work method statement (SWMS) is required for undertaking high-risk work, which must be followed.

Material Safety Data Sheet (MSDS) should also be supplied and referred to.

In consultation with WorkSafe Victoria the CEC has been advised that when considering the potential of a fall from height the below Falls Hierarchy of Control be followed. WorkSafe Victoria has advised that a harness is considered to be personal protective equipment (PPE).

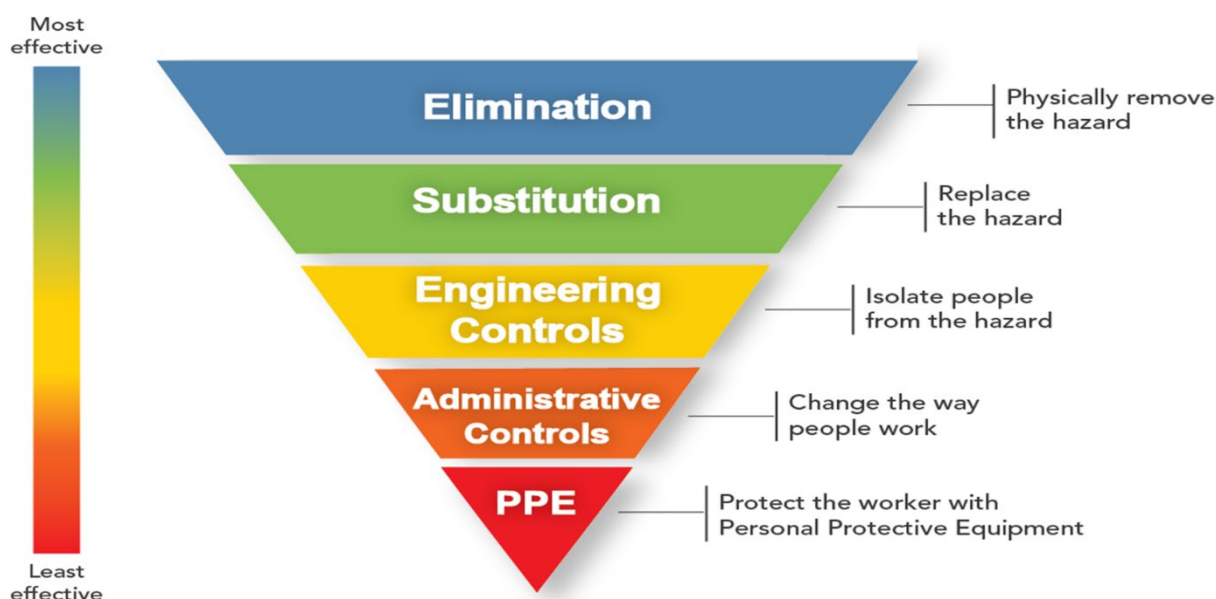

Across Australia, each state and territory has different definitions and requirements for their obligations towards WH&S. If you need help, please contact your state or territory work health and safety authority. Contact details are listed in Section 18 Attachment 3.

5 DOCUMENTATION

All complex systems require a user manual for the system owner. Grid-connected PV systems are no different.

The following system installation documentation shall be provided (as specified in AS/NZS 5033:2014, inc amdt 1&2, AN/NZS 4777.1:2016 and CEC Guidelines). The documentation can be either supplied in hard copy or electronic form (at the system owner's discretion).

Where the accredited installer is not also signing off as the CEC accredited designer for the installation, the accredited designer that is signing off on the installation shall provide the information as indicated below.

- 5.1.1 A list of equipment supplied with model, description and serial numbers – obtained from the CEC designer.
- 5.1.2 Basic system information including system rating (including but not limited to PV size, inverter size, PV array maximum voltages and currents) and component ratings, commissioning date and equipment location.
- 5.1.3 A list of actions to be taken in the event of an earth fault alarm – including any remote monitoring configuration.
- 5.1.4 A site specific shutdown and isolation procedure for emergency and maintenance.
- 5.1.5 A basic connection diagram that includes the string configurations, electrical ratings of the PV array, the ratings of all overcurrent devices and switches as installed – obtained from the CEC designer.
- 5.1.6 A site specific System Performance Estimate – obtained from the CEC designer.
- 5.1.7 Recommended maintenance for the system – obtained from the CEC designer.
- 5.1.8 Maintenance procedure and timetable – obtained from the CEC designer.
- 5.1.9 The commissioning sheets and installation checklist.
- 5.1.10 Array frame engineering certificate for wind and mechanical loading – obtained from the CEC

designer.

- 5.1.11 Installer/designer's declaration of compliance.
- 5.1.12 Warranty information – obtained from the CEC designer.
- 5.1.13 Equipment manufacturer's documentation and handbooks for all equipment supplied – obtained from the CEC designer.
- 5.1.14 Contact details for any installation enquiries and system support.
- 5.1.15 Voltage rise calculations or measurements.
- 5.1.16 Details of any central protection, phase balancing or export control installed, including devices, wiring and settings.

6 RESPONSIBILITIES OF ACCREDITED PERSON

6.1 Signing Off as an Accredited Person

6.1.1 An Accredited Person shall only sign off on systems where they have:

- Undertaken the installation; or
- Supervised the installation by others

Supervision includes attending the site during:

- job set up;
- mid-installation check-up; and
- testing and commissioning

6.1.2 Sign off is defined as the installer or supervisor performing the testing and commissioning requirements stated in Section 14.

6.1.3 The date of sign off is the day that the installer or supervisor performs the testing and commissioning requirements.

NOTE: It is vitally important that a system is tested as per the commissioning requirements of this document to ensure it is safe at the time of final sign off.

6.2 Limits apply to the number of installations an Accredited Person shall sign off per day

6.2.1 Where an Accredited Person is installing or supervising complete installations only, they shall not sign off on more than two (2) installations per day.

6.2.2 Where an Accredited Person is installing or supervising complete installations and upgrades/repairs (e.g. the installation or replacement of modules only) in the same day, they shall not sign off more than one (1) complete installations and more than three (3) upgrades on the same day.

6.2.3 Where an accredited person is installing or supervising upgrades and/or repairs to existing systems involving the installation or replacement of modules only, the installer or supervisor shall not sign off on more than four (4) system upgrades/repairs per day.

NOTE: The reasoning behind these requirements is to ensure integrity is maintained in the solar industry and that all systems are installed in a safe manner and meet all the Guidelines and Standards. Data from previous audit regimes identified that there was a direct correlation between systems deemed to require rectification (sub-standard installation) and the number of systems signed off in one day.

6.3 Multiple systems at one location

If a project involves multiple systems at one location, where the systems are installed in stages, the Accredited Person installing or supervising these installations may request a formal exemption from clause 6.2 to sign off up to ten (10) systems per day.

Example: multiple systems installed on an apartment block, or at a retirement village, where the cables are roughed in on one date; the inverter, mounting frame and modules installed on another date and the final connection and commissioning on another date.

- 6.3.1 An installer shall contact the CEC and request an exemption from clause 6.2 prior to the commencement of the project. Exemptions to clause 6.2 **WILL NOT** be granted after a project has commenced.
- 6.3.2 The installer must provide details of the project and the installation schedule for assessment by the CEC. Exemptions may be granted by the CEC to installers who can demonstrate that the schedule of installation will ensure all systems are installed in a safe manner and meet all Guidelines and Standards.
- 6.3.3 Once the assessment is complete, the CEC will respond to the installer with a letter detailing the assessment findings and exemption from clause 6.2.1 if granted. This letter shall be the only acceptable evidence of an exemption from clause 6.2.1 for the purposes of STC creation.

NOTE: An administration fee may apply for exemption request assessments in the future.

6.4 Grid connect battery backup system

- 6.4.1 When installing a grid connect battery backup system, the installation shall be performed by an accredited installer with a grid connected battery endorsement.
- 6.4.2 The CEC's Battery Install Guidelines for Accredited Installers shall be followed in conjunction with the relevant standards.

NOTE: The installation of battery storage has additional safety risks associated with the installation.

These include:

- electrical
- energy
- fire
- chemical
- explosive gas
- mechanical

7 PV ARRAY INSTALLATION

7.1 General

- 7.1.1 PV arrays for installation on domestic dwellings shall not have PV array maximum voltages greater than 600 V.
- 7.1.2 The following types of buildings are considered “domestic dwellings”, using the building classifications in the [National Construction Code](#):
- Class 1 (e.g. a free-standing house, terrace house, town house or villa unit)
 - Class 2 (e.g. an apartment block.)
 - Class 3 (e.g. a hotel/motel, boarding house or guest house)
 - Class 10a (e.g. a private garage, carport or shed)
- 7.1.3 Modules that are electrically in the same string shall all be installed at the same tilt angle (± 5 degrees) and orientation (± 5 degrees), unless using DC conditioning units or micro-inverters.
- 7.1.4 Unless specified by the CEC system designer, the installer shall not install two parallel strings, connected to the same Maximum Power Point Tracker (MPPT) input at the inverter, installed on different orientations (e.g. east and west).

NOTE: Some manufacturers will not guarantee inverter performance where parallel strings are installed on different orientations. The system designer shall confirm in writing that this arrangement is acceptable with the inverter manufacturer.

- 7.1.5 Modules should be installed at a minimum tilt of 10° to take advantage of self-cleaning during rain events. Where modules are installed at a tilt angle of less than 10° the system owner shall be advised about the need for more frequent cleaning of the modules, and this should be included in the recommended maintenance schedule provided to the system owner.
- 7.1.6 The CEC recommends modules be installed with a space in between at least every four (4) rows allowing adequate access for servicing and maintenance purposes. Skylights are not to be considered a space in between modules. It is also recommended spaces be allowed around the edge of the arrays as walkways.

7.2 Roof mounting (not building integrated)

- 7.2.1 All array supports, brackets, screws and other metal parts shall be:
- of suitable low-corrosion materials;
 - suitable for the lifetime and duty of the system; and
 - installed to ensure they do not increase their rates of corrosion when mounted together in an array and when mounted on the surface of the underlying structure.

This may include techniques to minimise corrosion rates appropriate to the local environment. Including, but not restricted to, methods such as non-reactive separators between metal surfaces, under screw/bolt heads and/or the selection of materials with appropriate type and thickness of anti-corrosive coating.

- 7.2.2 Refer to the manufacturer's installation manual to ensure that the materials introduced are compatible with the roofing.
- 7.2.3 Any roof penetrations shall be suitably sealed and waterproofed for the expected life of the system. (Refer to roofing manufacturer's installation manual.) See section 9.1.10 for more details. If this is not possible, this shall be detailed in the system's maintenance timetable.
- 7.2.4 It is important to allow enough clearance under the array to facilitate self-cleaning of the roof to prevent the build-up of leaves and other debris (refer to roofing manufacturer's installation manual.)
- 7.2.5 If fauna (such as birds, vermin, etc) are a problem in the vicinity of the installation, consideration should be given to how to prevent them gaining access to the roof area under the array.
- 7.2.6 Tiles shall sit flat after the installation of tile mounting brackets to ensure the tiles maintain their original ingress protection. There may be a requirement to grind the underside of the tile to enable it to sit correctly.

These are examples of tiles **not** maintaining their original ingress protection.



- 7.2.7 Where monocrystalline or polycrystalline modules are used, at least 50 mm clearance should be allowed below the array for cooling by natural ventilation. Insufficient ventilation will result in high operating temperatures for the modules.
- 7.2.8 The installer shall follow the array frame supplier/manufacturer's installation manual when mounting the array to the roof support structure to ensure that the array structure meets AS/NZS1170.2:2011 certification.
- 7.2.9 Where timber is used, it shall be suitable for long-term external use and fixed so that trapped moisture cannot cause corrosion of the roof and/or rotting of the timber. The expected replacement time should be stated in the system maintenance documentation.

NOTE: Attachment 2 provides some guidance on meeting the wind loading requirements of AS/NZS1170.2:2011.

7.3 Free standing PV arrays

- 7.3.1 The array mounting frame shall be wind rated in accordance with AS/NZS 1170.2:2011 part 2: Wind loads.
- 7.3.2 Installation of footings, posts and/or in-ground fasteners shall follow the manufacturer's instructions and installation manual.

7.4 Building integrated (BIPV) installations

- 7.4.1 The installation of modules that are being used as building material (e.g. tiles, building walls, sun-screens) shall only be installed by a person qualified to install that particular type of building element and the accredited installer/s.
- 7.4.2 Isolators shall be installed in accordance with clause 7.9.1, 7.10.1 and 7.10.2.
- 7.4.3 Roof tiles shall be installed in accordance with these Guidelines and all relevant Standards and the additional requirements as specified by the manufacturer's install instructions.
- 7.4.4 Modules shall be on the CEC approved module list at the time of install.
- 7.4.5 Cables shall be installed in heavy duty conduit or manufacturer designed containment that meets the requirements of AS/NZS5033:2014 amdt 1&2 clause 4.3.6.3.2.

7.5 Verification of AS/NZS1170.2:2011

- 7.5.1 Installers shall obtain from their frame supplier a copy of the engineering certificate stating that the array frame is certified to AS/NZS1170.2:2011 for the installation location.
- 7.5.2 Installers shall obtain information on how the frame is to be mounted on the roof to maintain this certification.
- 7.5.3 The array frame shall be installed to the manufacturer's instructions to ensure that the array structure meets AS/NZS1170.2:2011 certification. The installer shall consider the following:
- spacing between fixings for specific wind load regions;
 - area of roof that is applicable for modules to be installed, some manufacturers only allow the frames to be installed within specific zones of the roof. Refer to manufactures installation manual and AS/NZS1170.2:2011, Appendix D6;
 - type, length and gauge of screws to be used;
 - number of screws required per fixing; and
 - size of batten/purlin required for fixing.
- 7.5.4 The installation checklist includes a clause stating that the system has been installed in accordance with the recommendations of the supplier/manufacturer. Copies of both these documents shall be included in the system documentation provided to the system owner.

NOTE: If installers are manufacturing their own frames, these require engineering certification and certificates shall be included in the system documentation provided to the system owner.

7.6 Attaching modules to array mounting structure

- 7.6.1 Solar modules shall be installed following the module manufacturers installation instructions. Solar modules shall be attached to the array structure using either the mounting holes provided by the manufacturer or via clamps.
- 7.6.2 Where modules are installed in such a way that the junction box is to the side or at the bottom, care must be taken to ensure this is permitted by the manufacturer.
- 7.6.3 When using clamps, the solar module manufacturer's installation manual shall be followed. The installer shall consider the following:
- amount of overhang allowed from clamp to end of module; and
 - size of clamp required.

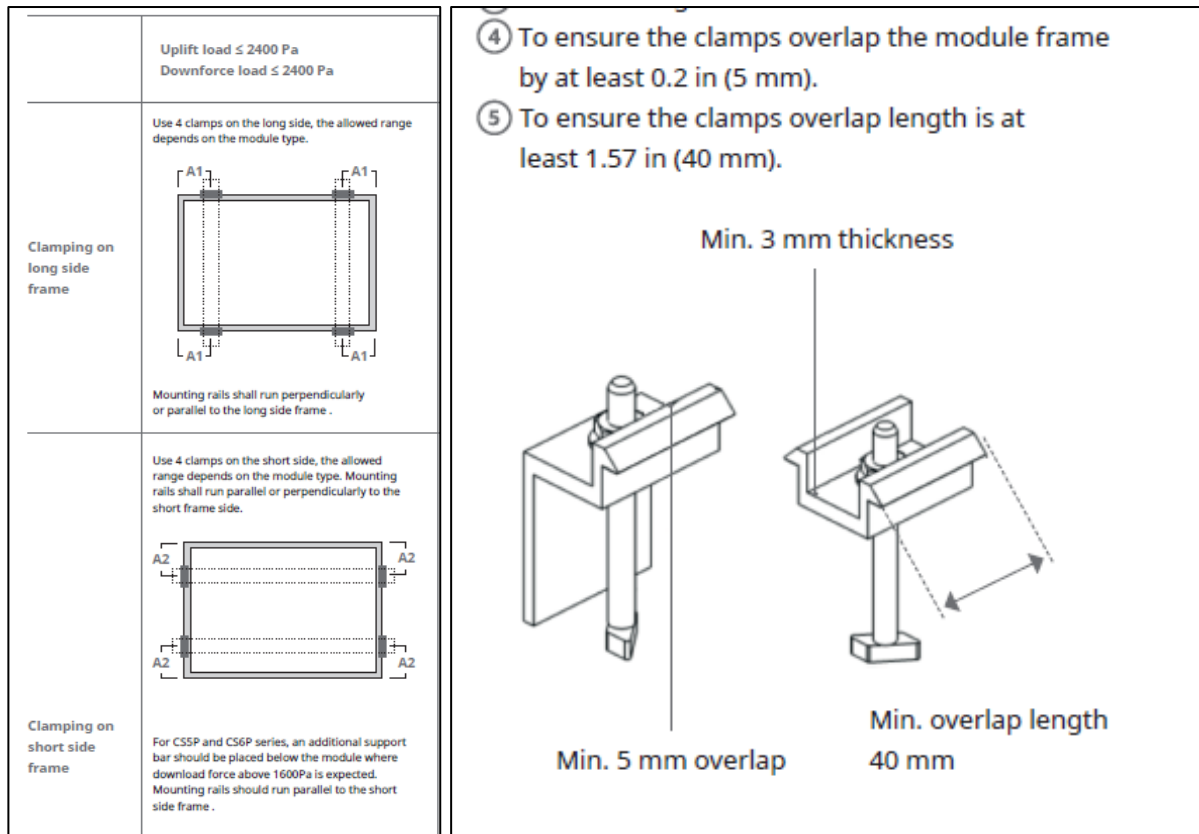

Image: Canadian Solar

NOTE: Attaching a solar module in such a manner (e.g. drilling, pop riveting) that causes a hole in the anodised aluminum frame of the solar module typically voids the manufacturer's product warranty with respect to defects in material and workmanship. If the installer intends to undertake an installation in this manner, they shall obtain written verification from the manufacturer that it does not affect the warranty. This shall be included in the system documentation provided to the system owner.

7.7 Earthing of array frames for a PV array with maximum voltage greater than ELV (including AC modules and micro inverter systems)

7.7.1 All exposed metal PV module frames and the array mounting frames shall be earthed where the PV array has a PV array maximum voltage (V_{oc} adjusted for lowest temperature) of greater than ELV or AC modules or micro inverters with LV outputs are installed.

7.7.2 Earthing conductors shall:

- have a minimum equipotential bonding earth cable size of 4 mm^2 for mechanical protection. Larger cables may be required. See AS/NZS 5033:2014 inc amdt 1&2 clause 4.4.2.2 and 4.4.2.3 for requirements.
- be protected by a corrosion-resistant material e.g. zinc spray AS/NZS3000:2018 clause 5.5.5.3.

7.7.3 Earth connections shall be:

- by a purpose-made fitting providing earthing or bonding connections for dissimilar metals and fitted to the manufacturer's instructions; or
- by purpose-made washers with serrations or teeth for the connection between the PV module and mounting frame fitted to the manufacturer's instructions; and
- be arranged so that the removal of a single module earth connection will not affect the continuity of the earthing or bonding connections to any other module.

7.7.4 Self-tapping screws shall not be used.

7.7.5 Ensure that rail joiners (splice) provide earth continuity. Some rail manufacturers state that the use of the rail joiner (splice) provides earth continuity between rails. If the manufacturer does not provide this information, an earth strap shall be installed across the join.

7.7.6 As per AS/NZS3000:2018 the earth cable can be insulated unsheathed cable except when exposed to direct sunlight. If exposed to direct sunlight, the insulated unsheathed cable shall be appropriately UV rated or have a physical barrier to prevent exposure to direct sunlight (e.g. UV rated conduit).

7.7.7 The earth cable shall be installed as per AS/NZS3000:2018 requirements. Particular attention shall be paid to mechanical protection and support. The earth cable cannot pass through a tile or steel roof without additional mechanical protection (conduit) and an appropriate collar flashing (e.g. dektite). The same conduit that is used for the PV array cable can also be used for the earth cable.

These are examples of earth cable that is **not** adequately mechanically protected.

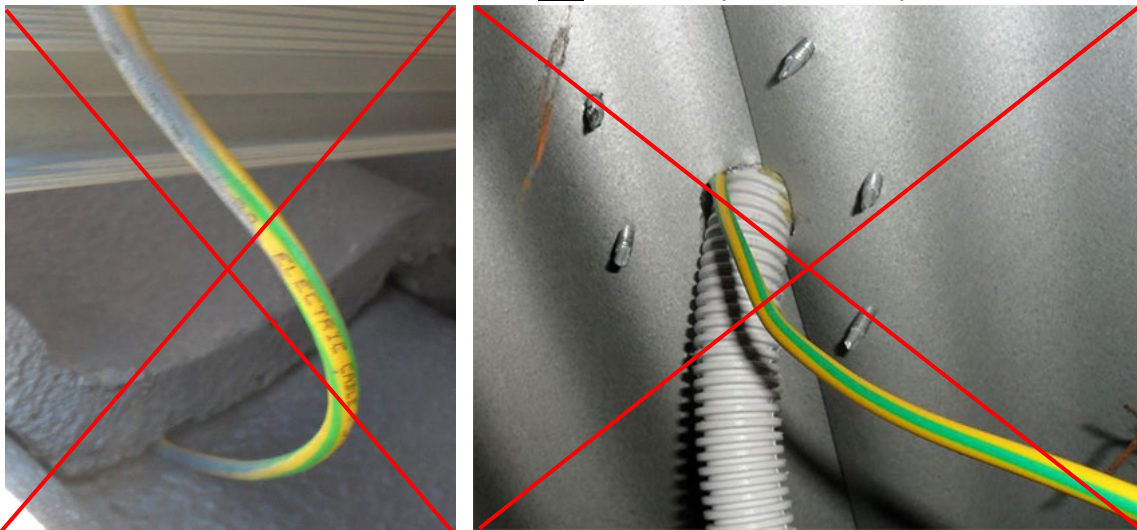

7.7.8 The earthing conductor from the PV array can connect to the inverter's main earth conductor in the AC output cable provided the following conditions are met:

- Installation is not subject to lightning
- Inverter AC earth is of an appropriate size:
 - For an Isolated inverter (transformer based) and floating array: inverter AC earth size is appropriate.
 - For Non isolated inverter (transformerless): earth conductor shall be sized according to AS/NZS 3000:2018 clause 5.3.3.1.2 using the size of the PV array cabling as the active conductor.
 - Functionally earthed arrays: see AS/NZS 5033 clause 4.4.2.2 for requirement.

NOTE: See AS/NZS5033:2014 inc. amdt 1&2 clause 4.4.2.2 for more detailed information regarding this requirement.

7.7.9 Where AC modules/micro inverters are installed at locations not subject to lightning, the earthing of the PV module and mounting frame may be achieved using the micro inverter earth connection (confirm with manufacturer and see AS/NZS5033:2014 inc amdt 1&2 clause 4.4.2.2)

7.8 Wiring at the PV array

7.8.1 The electrical installation of the array shall be in accordance with AS/NZS5033:2014 inc amdt 1&2.

7.8.2 All LV wiring shall be undertaken by a licensed electrician.

7.8.3 Plastic cable ties are not to be used as the primary means of support.

7.8.4 The PV array wiring shall comply with the wiring requirements of AS/NZS3000:2018.

7.8.5 Cables shall be protected from mechanical damage.

7.8.6 Plug connectors are to be selected and installed appropriately.

- Plug connectors shall be selected for the appropriate cross-sectional area of the PV conductor and fitted off as per manufactures instructions.
- Plug connectors are rated to IP68. The installer shall ensure that all connectors are waterproof as per manufactures instructions. This may require matching the outside diameter (OD) of the PV cable (including the insulation) to the inside diameter (ID) of the cable gland on the plug connector.
- Only connectors which are the same type, from the same manufacturer, shall be matched and mated pairs at the connection point.

NOTE: Over and under tightening plug connector entry glands may compromise IP rating.

Consider the cable bending radius where entering plug connectors.

7.8.7 Cables shall not touch roofs or floors without an enclosure or conduit.

7.8.8 Cable size to be determined by AS/NZS5033:2014 inc amdt 1&2 clause 4.3.6.1.

7.8.9 For LV PV arrays under maximum load conditions (Imp), the voltage drop from the most remote module in the array to the input of the inverter should not exceed 3% of the Vmp voltage (at STC).

7.8.10 In particular, refer AS/NZS3000:2018 clause 3.3.2.10 "Where the presence of fauna is expected to constitute a hazard, either the wiring system shall be selected accordingly, or special protective measures shall be adopted".

- 7.8.11 All conduit connections shall be glued.
- 7.8.12 All conduits exposed to direct sunlight shall be suitably UV rated.

7.9 AC and DC PV array isolators

- 7.9.1 An isolator shall be installed adjacent to the array. For LV systems where this isolator is not visible from the Power Conversion Equipment (PCE) an isolator shall also be installed adjacent to or within the PCE. This is to enable safe disconnection of the array and isolation of the PV array cable. AS/NZS 5033:2014 inc amdt 1&2 clause 4.4.1.5.
- 7.9.2 Isolators shall not be fixed on any portion of the module.
- 7.9.3 Isolators shall be readily available (this is defined as “capable of being reached for inspection, maintenance or repairs without necessitating the dismantling of structural parts, cupboards, benches or the like.”)
- 7.9.4 Isolators shall be labelled as per sections 15.1 for DC systems and 15.2 for micro-inverter systems
- 7.9.5 Where a condensation issue could arise within electrical equipment, a breathing/pressure equalisation valve shall be installed. Refer to AS/NZS3000:2018 clause 1.7.2

NOTE: Below is an example of a breathing/pressure equalisation valve.



7.10 DC PV array isolators

The positive and negative terminal of a solar array or sub-array represents a potentially high-risk hazard when the output voltage is 120V DC or above. See Attachment 1 for more details.

All DC isolators shall comply with Section 8 but there are some additional requirements for DC isolator/s installed at the PV array/s.

- 7.10.1 DC Isolators shall not be installed mid string. For example, where one electrical string is split over different roof faces (all faces are at the same orientation), one isolator is required at the point where the PV module wiring transitions from the PV array wiring to the PV array inverter wiring.

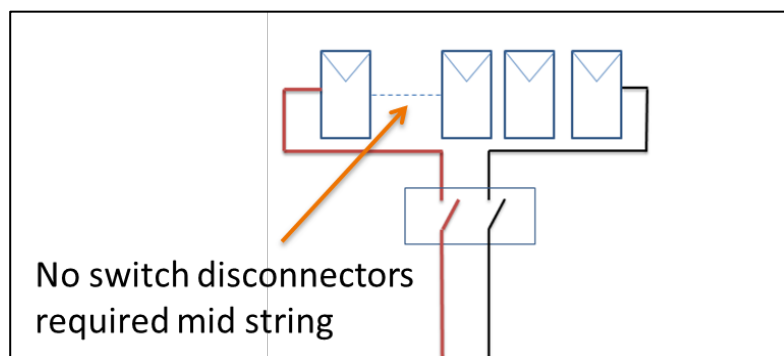

- 7.10.2 PV DC isolator(s) shall not be installed under a solar module when the modules are parallel to the roof. Where the modules are installed parallel to the roof, a shroud shall be installed over the isolator.
- 7.10.3 Isolators shall not have direct exposure to sun and rain AS/NZS5033:2014 amdt 2:2018 clause 4.3.3.3.2(a).

NOTE: For an array facing north with a pitch of 22°, the following examples may satisfy the requirements provided the isolators are mounted in accordance with Section 8.3.2.

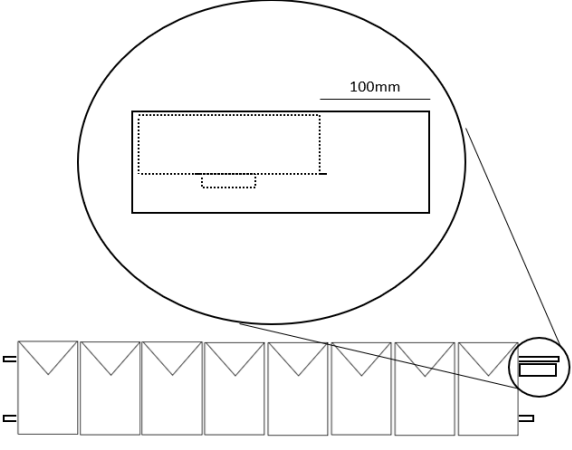
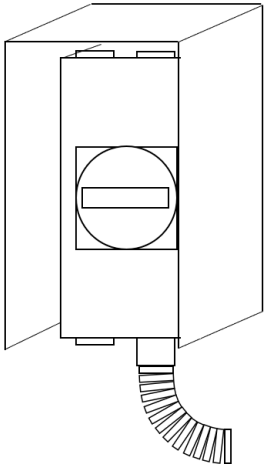
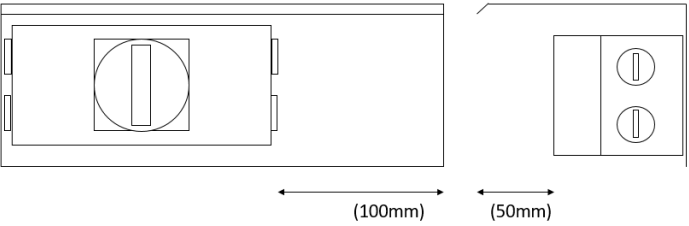
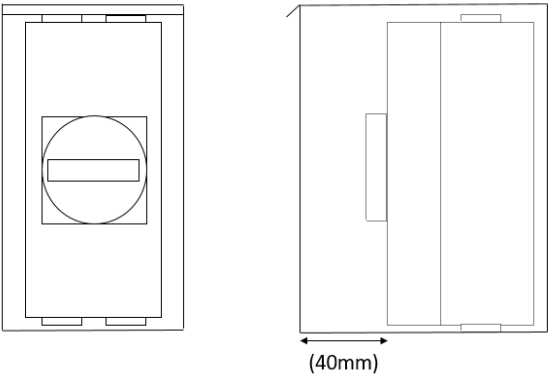
Isolators can only be mounted this way if the manufacturer specifically allows it	Front of the isolator to face south to protect from exposure to sun
	
	

- 7.10.4 Where the modules are installed on a tilt frame, the isolator shall be protected from direct exposure to sun and rain by using either of the following methods:
- Installation of a shroud as per 7.10.2; or
 - Installation beneath the modules

NOTE: Water ingress into DC wiring systems can result in arcing and fires. Installers shall follow Section 8.3, installing DC isolation devices to mitigate this risk.

8 DC Isolator and string protection

8.1 Selecting DC isolation devices

Electricians are required to install load breaking disconnecting devices at various places in a solar installation.

8.1.1 A circuit breaker can be used as a DC isolator providing it meets AS/NZS5033:2014 inc amdt 1&2 (including clause 4.3.5.4) and the following conditions are met:

- certified to either AS/NZS 60898.2 or IEC 60947.2;
- be rated correctly as per section clause 8.2;
- not be polarity sensitive; and
- rated for DC use

8.1.2 A switch disconnecter can be used as a DC isolator providing it meets AS/NZS5033:2014 inc amdt 1&2 (including clause 4.3.5.2) and the following conditions are met:

- certified to AS 60947.3 for the location they are to be installed in (see note);
- IP rating of IP56NW;
- have a utilisation category of DC-PV2;
- be rated correctly as per section 8.2;
- switch all live conductors simultaneously;
- capable of being secured in the open position;
- be independent manual operation;
- be rated for DC use; and
- not be polarity sensitive

NOTE: There are several ways to classify switch disconnectors. Classifications include:

- DC isolator classified as 'enclosed indoor' with a dedicated individual enclosure
- DC isolator classified as 'enclosed indoor' without a dedicated individual enclosure
- DC isolators classified as 'enclosed outdoors' with an individual dedicated enclosure
- DC isolator installed within PCEs (including inverters)

8.1.3 Isolators with an individual dedicated enclosure that are installed outdoors shall have manufacturer's documentation declaring that they comply with 60947.3 and are certified for outdoor use.

Some States require (and the CEC recommends) only using isolators on the ERAC approved DC isolator list which can be found at; <https://equipment.erac.gov.au/Registration/>

The following information shall be displayed on the face of the isolator and be visible once installed:

- symbol for isolation under load
- indication of open and close positions of switch actuator
- manufacturers name or trade mark
- model number/serial number/type designation
- wording 'IP56NW'
- wording 'AS 60947-3'

NOTE: The markings on the front of the isolator give you a good clue as to whether the isolator is compliant with AS/NZS5033:2014 Amendment 2.

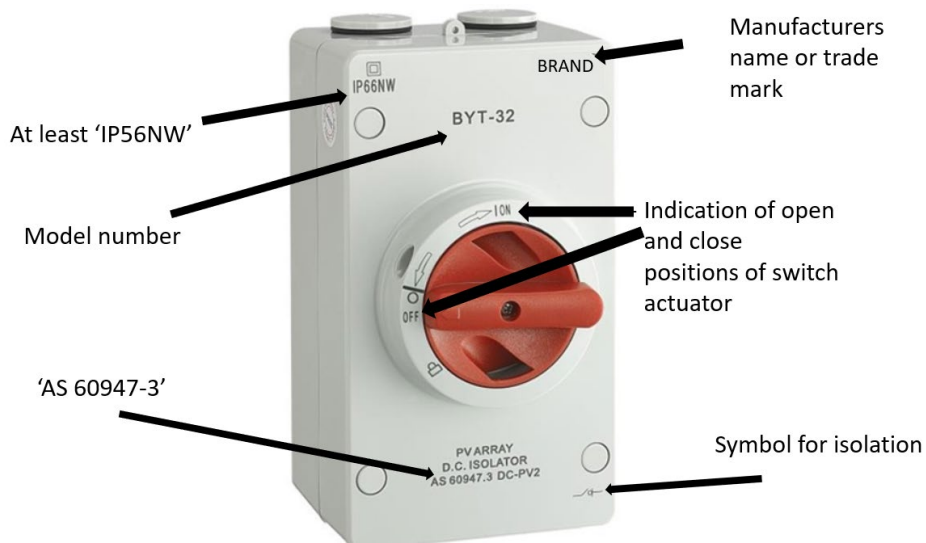

8.1.4 Switch disconnectors need to be selected for the installed environment as per AS/NZS5033:2014 inc amdt 1&2 clause 4.3. The requirements of AS/NZS5033:2014 inc amdt 1&2 clause 4.3.3.2 shall be followed on domestic and non-domestic installations.

NOTE: The following figure gives a summary of switch disconnectors that are built into inverters/PCEs and are within dedicated individual enclosures. See AS/NZS5033:2014 inc amdt 1&2 for more information on switch disconnectors within PV enclosures for assemblies.

Selecting PV isolators

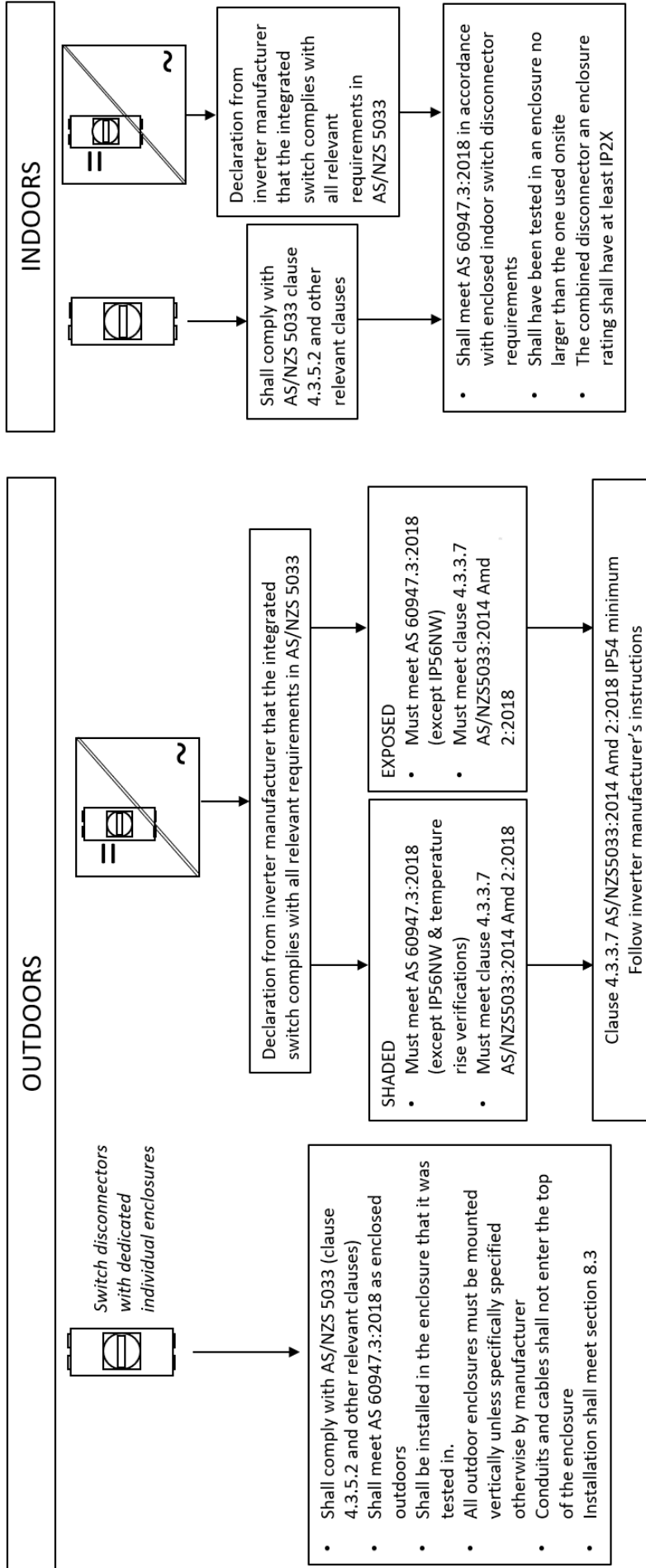

*This is a guide, please see AS/NZS 5033 for actual installation rules

Figure 8.1

8.2 Sizing DC Isolation devices

There are different ways to size a switch disconnecter depending on the topology of the inverter and the type of switch and enclosure that is being used:

- 8.2.1 Transformer based inverter – the requirement for the switch disconnecter and the circuit breaker for full load current and prospective fault current can be met by sizing it to the full load current at the PV array maximum voltage.
- 8.2.2 Transformer-less inverter – the requirement for the switch disconnecter and the circuit breaker to break full load current and prospective fault current at the PV array maximum voltage is met in different ways depending if you are using;
- Switch disconnecter (integrated into the inverter);
 - Switch disconnecter (separate from the inverter); or
 - Circuit breaker (see Figure 8.3)
- 8.2.3 The current rating of DC isolation devices de-rate as the temperature increases. It is the installer's responsibility to de-rate the switch disconnecter for the expected ambient temperature onsite. Installers shall base the minimum ambient temperatures on AS/NZS5033:2014 inc amdt 1&2, which can be summarized by the following:
- indoor installations 40° celsius
 - outdoor installations shade 40° celsius
 - outdoor installations exposed 60° celsius

NOTE: Isolators mounted under a shroud are not considered 'shaded' for the purpose of this clause. Check manufacturers derating documentation to size the switch for the location it will be installed in.

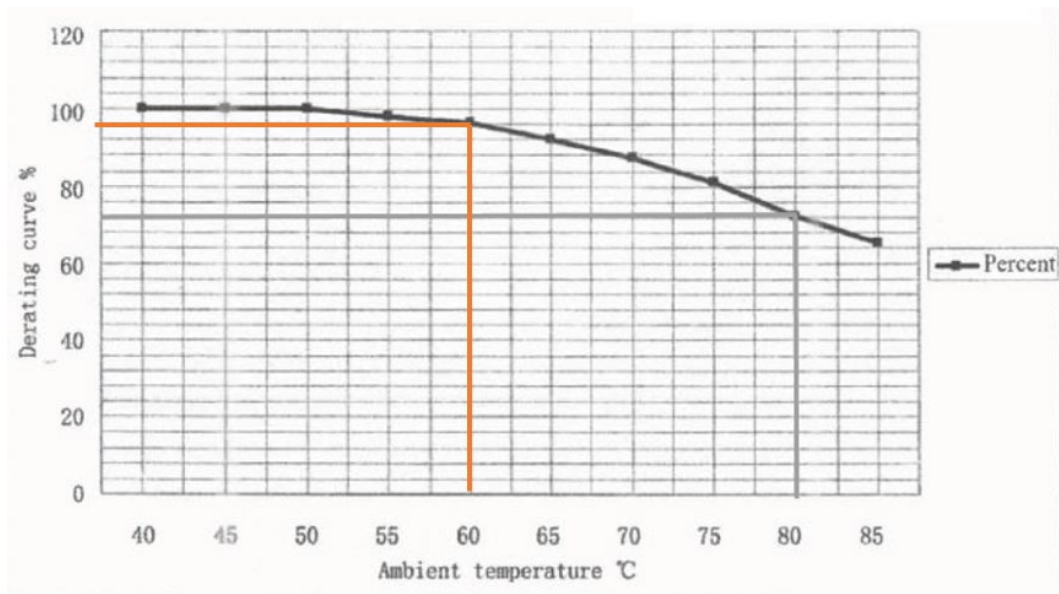

Figure 8.2 Example of temperature de-rating curve showing de-rating points at 60° and 80°

- 8.2.4 Functionally earthed arrays present specific issues. The voltage rating of isolators for these systems are detailed in AS/NZS5033:2014 inc amdt 1&2 Appendix B.

SIZING PV DISCONNECTORS

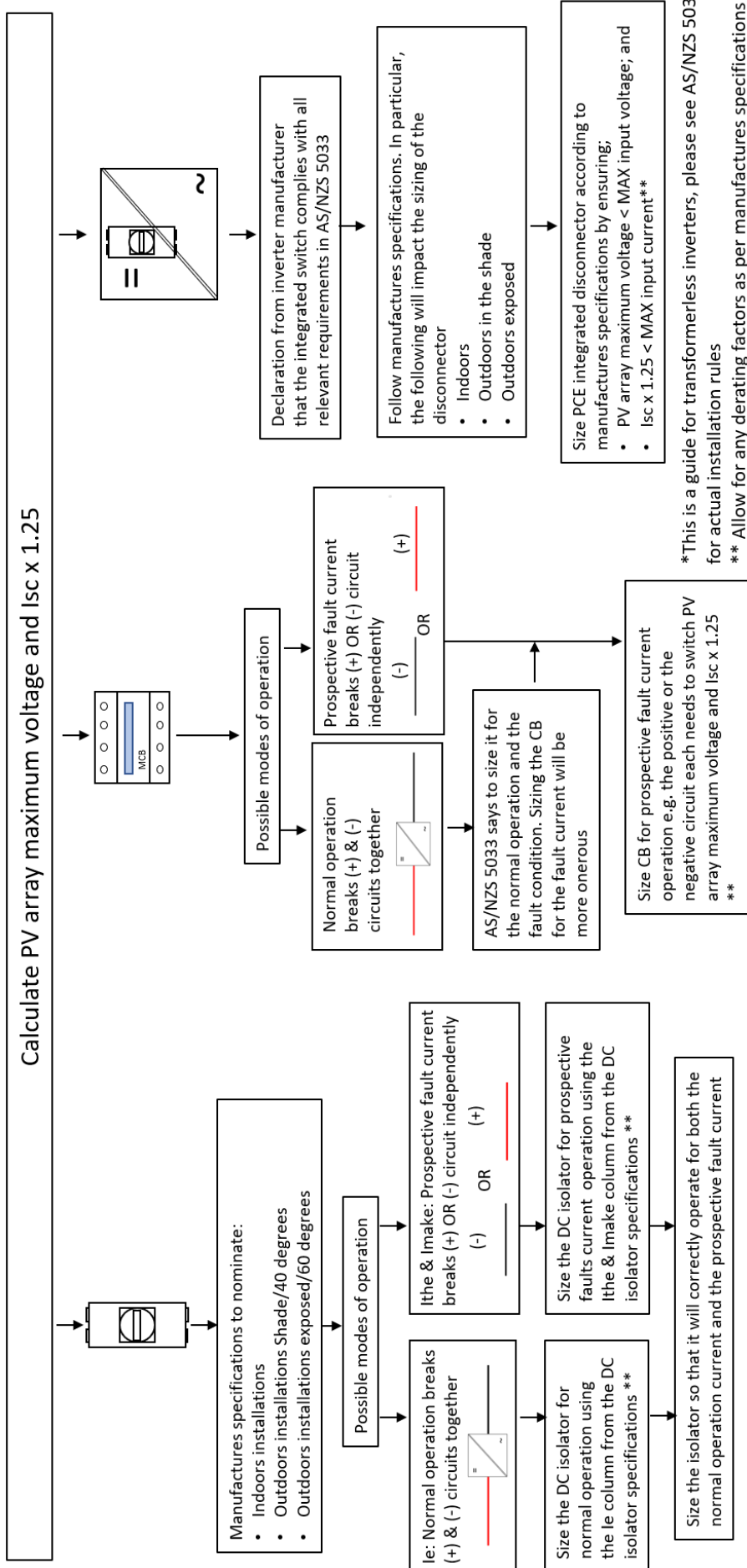

Figure 8.3

8.3 Installing DC Isolation devices

Water ingress into DC wiring systems can result in arcing and fires. This is a high-risk area of the solar industry so it is important and compulsory to adopt the following measures to minimise the chance of water ingress for DC isolators installed in outdoor locations.

- 8.3.1 DC isolators and their enclosures shall be selected appropriately as per section 8.1.
- 8.3.2 Unless otherwise specifically stated by the isolator manufacturer, isolators shall be mounted in the vertical position. This means the long edge of the isolator shall be vertical unless otherwise specified by the manufacturer.

NOTE: If you want to mount an isolator horizontally on a rail with a 22° pitch, you may need to choose an isolator that can be mounted in any plane. Below is an example of how manufacturers may display mounting positions.

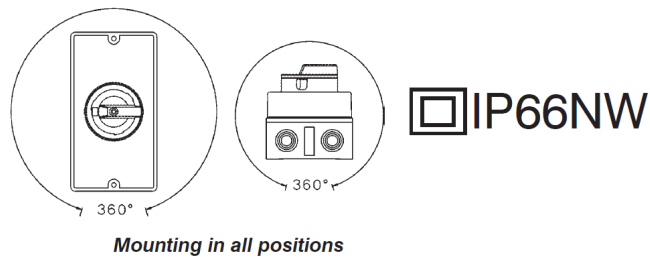

- 8.3.3 Isolators shall be fixed to PV array supports by the use of stainless steel fixings (or by fixings of galvanically similar material) to minimise corrosion.
- 8.3.4 The recommended method of fixing is by using fixing points that are on the outside of the enclosure (where possible) to minimise penetrations and water ingress.
- 8.3.5 When internal fixing points are used, follow the manufacturer's installation manual to maintain IP rating.
- 8.3.6 All screw cover caps that are supplied shall be installed.
- 8.3.7 All internal mounting holes shall be sealed according to AS/NZS5033:2014 amdt 1:2018, clause 4.4.4.6.



Example of how **not** to install an isolator.

External fixing points should be used to minimise the chance of water ingress

If the cable becomes disconnected it could liven up the mounting structure

- 8.3.8 IP rating shall be maintained through use of multi-hole glands.
- 8.3.9 No dust or debris shall be left once mounted.
- 8.3.10 Only manufacturer provided entry points shall be used.
- 8.3.11 Penetrations shall be sealed following manufacturer's instructions including using glue or nylon tape if necessary.
- 8.3.12 Installers shall use penetrations at the lower entry face first. Entry points on the vertical side are only to be used if:
 - permitted by the manufacturer;
 - the IP rating is maintained; and
 - it is not practical to enter via the lower entry face.

Top entry face penetrations are not permitted when installed outdoors.

- 8.3.13 Where an entry/exit is a conduit adaptor, the adaptor shall be rated at least IP 55. The CEC recommends at least IP 66. Other suitable options are IP67 glue-less conduit fittings.



Image: Cobalt Solar

- 8.3.14 Where the entry/exit to an enclosure is a cable gland, the following conditions shall be met:
 - The gland shall be rated to at least IP 56.
 - Where multiple cables go through one gland, a multi-hole cable gland shall be used.
 - Where a multi-hole cable gland is used, each cable shall go through an appropriately sized hole.
 - Products like silicone are not appropriate as a primary means of sealing.

EXCEPTION: This is not a requirement where cables enter/exit a conduit that is open at both ends (e.g. surface mounted conduits used for mechanical protection linking modules from one part of a string to another).

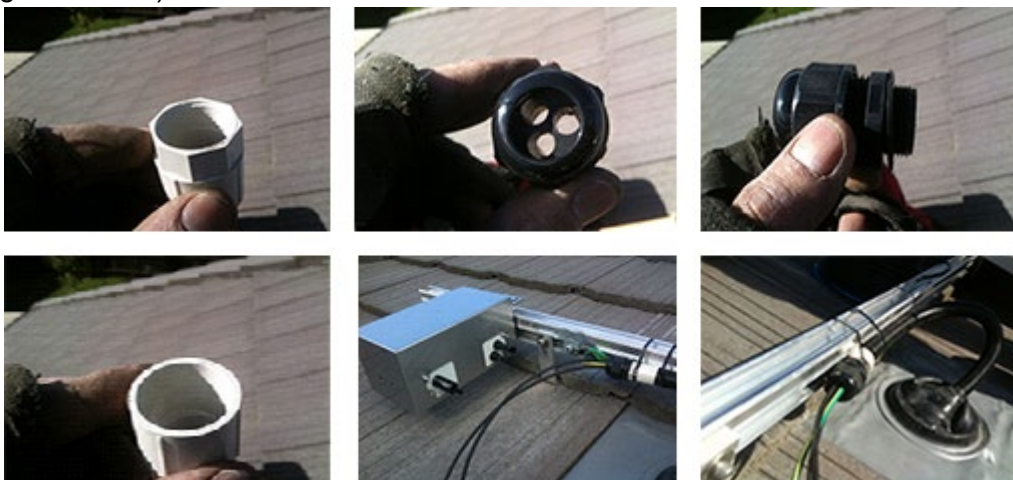

8.4 String protection

Faults due to short circuits in modules, junction boxes, combiner boxes, module wiring or earth faults in array wiring can result in overcurrent within a PV array.

- 8.4.1 Overcurrent protection shall be provided where it is required by manufacturers of PV modules. The key criteria for this is the module's "Maximum Series Fuse Rating", sometimes listed as "Maximum Reverse Current".
- 8.4.2 AS/NZS5033:2014 inc amdt 1&2 clause 3.3.4 defines the formula to calculate if string protection is required.
- 8.4.3 AS/NZS5033:2014 inc amdt 1&2 clause 3.3.5.1 defines the rating of the fuse protection.
- 8.4.4 In LV arrays, overcurrent protective devices, where required, shall be placed in all current carrying conductors not directly connected to earth.
- 8.4.5 In ELV arrays, overcurrent protective devices, where required for string and sub-array cables, shall be placed in either the positive or negative conductor (the number of current carrying conductors minus one).

9 PV ARRAY CABLE BETWEEN ARRAY AND INVERTER

- 9.1.1 Installing enclosures, junction and combiner boxes outdoors.
 - Junction/combiner boxes: at least IP 55. The CEC recommends IP 66. IP rating of enclosures shall be maintained.
 - Enclosures shall be UV resistant when installed in the outdoor environment.
 - To reduce the chance of water entering the conduit system, enclosures shall be installed as per the requirements of section 8.3.4 to 8.3.14.
- 9.1.2 DC cables shall comply with the wiring requirements of AS/NZS3000:2018 and/or AS/NZS5033:2014 inc amdt 1&2.
- 9.1.3 Domestic: PV array cables within a domestic building that are installed in ceiling spaces, wall cavities or under floors shall be enclosed in metal or heavy-duty (HD) insulating conduit. When installed in a building, other than those listed previously, the PV array cable shall be in medium-duty (MD) conduit as a minimum.

NOTE: The intention of this is to provide additional protection for cables in locations where they may not be visible (e.g. a person drilling a hole into a wall cavity will hit the conduit first before making contact with the cables). Where cables are installed inside buildings but clearly visible (e.g. surface mounted conduit on the inside of a garage wall), MD conduit is acceptable as an alternative.
- 9.1.4 Non-domestic: see AS/NZS5033:2014 inc amdt 1&2 clause 4.3.6.3.2 for requirements.
- 9.1.5 Wiring systems concealed in walls but within 50mm of a building surface require protection from mechanical damage as per AS/NZS3000:2018 clause 3.9.4. PVC HD conduit may not be sufficient in some cases.

- 9.1.6 Conduits shall be installed so that they are adequately supported as per AS/NZS3000:2018. These are examples of conduit that is **not** adequately supported.

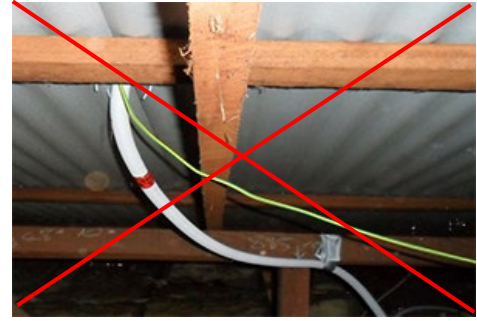

- 9.1.7 AS/NZS5033:2014 inc amdt 1&2 does not allow for any MD conduit to be installed in the ceiling space. Ensure that the transition from MD conduit to HD conduit occurs at the point of penetration of the roof. Alternatively, UV-rated HD corrugated conduit could be used where the cable enters the ceiling space.
- 9.1.8 Double insulation of each conductor shall be maintained within wiring enclosures (e.g. conduit).
- 9.1.9 The wiring enclosure shall be visibly labelled 'SOLAR' at not more than 2 metre intervals and at all change of direction.
- 9.1.10 Where the PV array cable and conduit passes through a tile or steel roof, a fit for purpose collar flashing shall be installed (e.g. dektite).



NOTE: Grinding a tile and passing the conduit between tile overlaps is not an acceptable method and breaches AS/NZS3000:2018 clause 3.9.4.3.1.

Conduit passing through a hole in a steel roof and then sealed with silicon is in breach of Standards Australia Handbook 39-1997 (clause 8.6).

Examples of **non-acceptable** methods.

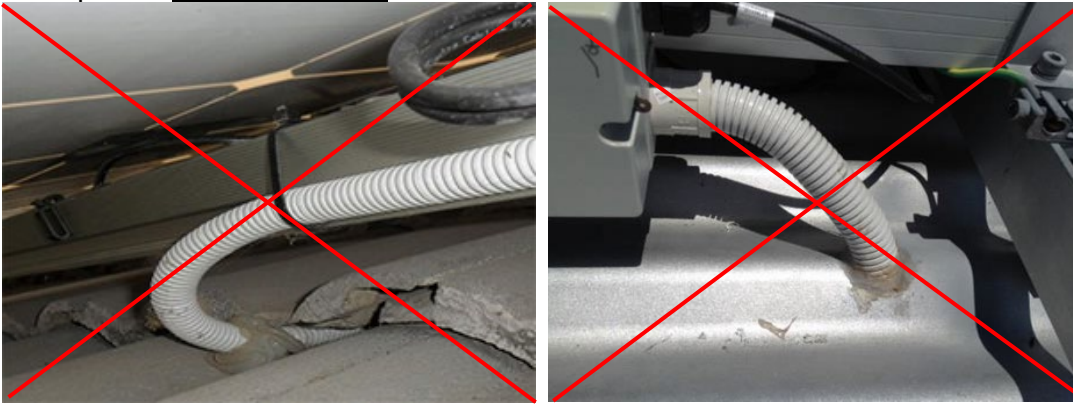

10 INVERTER INSTALLATION

10.1.1 The inverter shall be installed in accordance with the manufacturer's instructions. The installer shall:

- Ensure the location is appropriate for the IP Rating of the inverter. Where this is not possible, then the inverter/s should be in an appropriate weatherproof enclosure.
- Comply with specific environmental requirements e.g. not exposed to direct sunlight, direct rain, etc.
- Ensure the mounting structure is able to support the inverter weight.
- Ensure the mounting structure material is appropriate for the inverter.
- Ensure recommended clearances around the inverter are followed.

10.1.2 There are restricted locations for mounting inverters, such as:

- Inverters shall only be mounted in areas appropriate for switchboards as per AS/NZS3000:2018 Section 2 General Arrangement, control and protection.
- Inverters shall not be mounted in any classified zone (e.g. spas, pools, etc.) as per AS/NZS:3000;2018 Section 6 Damp Situations.
- Installation of inverters shall comply with local regulations (e.g. mounting heights may differ in different jurisdictions).

10.1.3 While inverter circuits are not considered final sub circuits, residual current devices (RCDs) may be used on inverter circuits to comply with AS/NZS3000:2018. Section 10.5.2 of these Guidelines shall be followed for selection of RCDs.

10.1.4 The inverter heat sink shall be clear of any obstacles to facilitate cooling of the inverter.

10.1.5 Cables connected to the inverter shall be mechanically secured in such a manner that they cannot be inadvertently unplugged from the inverter.

This can be achieved by:

- installing the inverter in an external enclosure (with cables suitably supported);
- the use of an inverter which has the cable connection area of the inverter covered by a removable enclosure/cover which protects the supported cables so that there are no exposed, unsupported cable loops;
- the use of conduit and secure wall fixings.

- 10.1.6 Where the inverter requires DC connectors to be used, a maximum allowable distance of no more than 300mm of unprotected DC cable shall be permitted between connectors and conduit, provided the location is not subject to mechanical damage.
- 10.1.7 Where the inverter is exposed to the weather and cables are required to enter/exit, the requirements of 8.3.4 to 8.3.14 shall be met.
- 10.1.8 The installer shall ensure that the inverter is configured for Australia and that the AS/NZS4777.2:2015 parameters are loaded.

NOTE: One method to ensure the AS/NZS4777.2:2015 parameters are installed is by monitoring the inverter power output when the inverter is turned on. If set correctly the inverter will not go straight to full power. It is required to ramp up from 0%-100% over a six-minute period.

- 10.1.9 The installer shall ensure that the grid parameters of the inverter are set to the local distributor's requirements.

10.2 PV array DC isolator near inverter (not applicable for micro inverter AC and modules systems)

- 10.2.1 Where the inverter in LV systems is not in sight of the array or more than 3 metres from the array, it must be possible to isolate the inverter from the array for maintenance to be carried out safely. This can be achieved through separate load breaking disconnectors or one that is integrated in the inverter.
- 10.2.2 For inverters with an integrated disconnecter; installers shall obtain documentation from the manufacturer declaring that their product complies with the relevant clause of AS/NZS5033:2014 inc Amdt 1&2.
- 10.2.3 All PV array switch-disconnectors shall be readily available. See Section 7.9.3 for details on readily available.
- 10.2.4 Where multiple disconnection devices are required to isolate power conversion equipment, they shall be:
 - grouped so that they all operate simultaneously, or
 - they shall all be grouped in a common location and have warning signs indicating the need to isolate multiple supplies to fully isolate the equipment (see Section 15 for examples of signs); and
 - they shall be individually labelled (e.g. "PV Array DC isolator inverter 1 MPPT A" and "PV Array DC isolator inverter 1 MPPT B").
 - The shutdown procedure shall align with the labelling of multiple isolators – see the following examples.

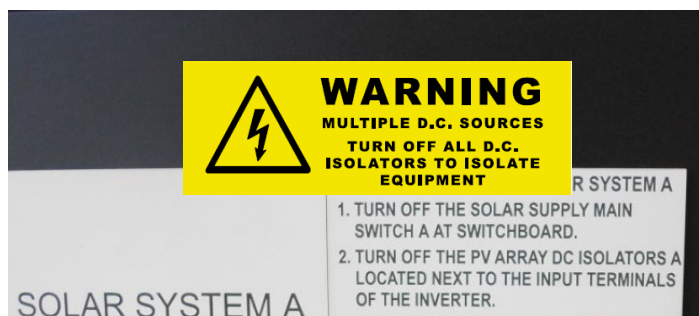

- 10.2.5 Where strings are paralleled at the inverter, the CEC recommends that this should occur on the inverter side of the disconnection devices, or in the inverter itself.

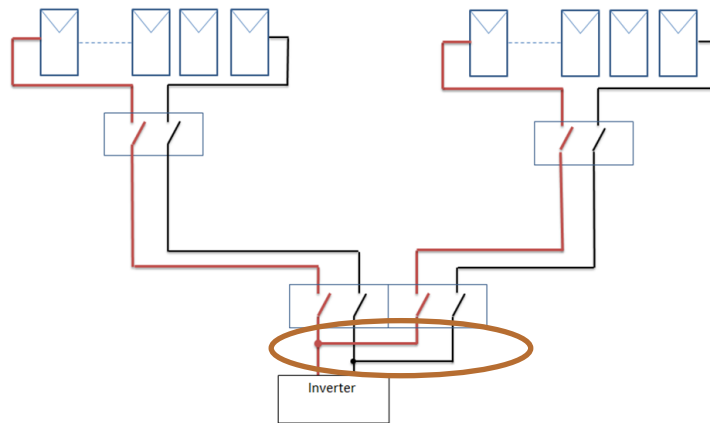

NOTE: This will enable the cable to either string to be safely de-energised, without the need to turn off both rooftop isolators.

- 10.2.6 DC isolator/s adjacent to the inverter shall meet the requirements of Section 8.
10.2.7 Where the inverter and isolator are installed outdoors, IP ratings shall be maintained as per section 8.3 and drip loops should be utilised at the bottom of the isolator to minimise water ingress.

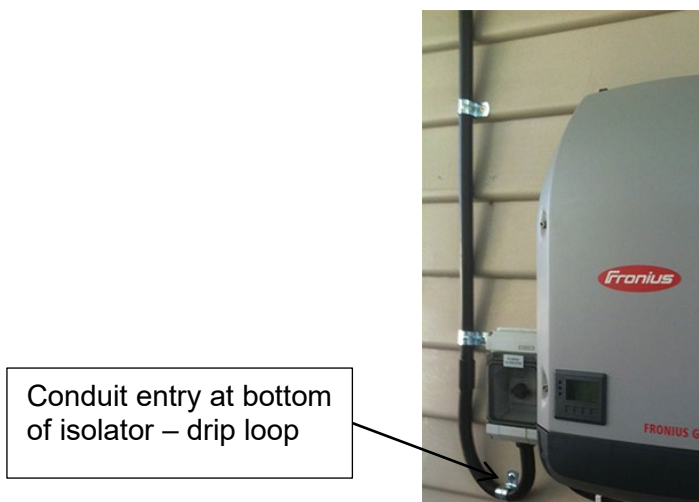

10.3 AC isolator near inverter

The purpose of the AC isolator is to de-energise the inverter for maintenance or fault rectification.

- 10.3.1 Where the inverter is not adjacent to the switchboard to which it is connected, an isolator shall be provided at the inverter, so that a person operating the switch has a clear view of any person working on the inverter - refer to AS/NZS3000:2018 clause 7.3.4.
10.3.2 Connection of AC and DC components in the same enclosure shall not be mounted on a common conductive mounting rail.
10.3.3 AC and DC circuits within the same enclosures shall be physically segregated by an insulation barrier, see AS/NZS5033:2014 inc amdt 1&2 clause 4.4.4.3, AS/NZS3000:2018 clause 3.9.8.3.

NOTE: this is to reduce the chance of AC and DC cables coming in to contact with each other.

- 10.3.4 Where the inverter and isolator are exposed to the weather the isolator shall have an IP rating of at least IP 55. The CEC recommends using isolators rated to IP 66.
- 10.3.5 Where an isolator is exposed to the weather, the CEC recommends that there be no top entries into the isolator and drip loops should be utilised at the bottom of the isolator to minimise water ingress.



10.4 AC Isolators for micro inverter installation

- 10.4.1 A labelled, lockable, isolating switch (inverter AC isolator) shall be installed at the point of transition from micro inverter interconnect cable to fixed wiring. The purpose of the AC isolator is to de-energise the AC from the micro inverters for maintenance or fault rectification
- 10.4.2 The isolator shall be installed adjacent to the inverter or inverter group. This isolator may be a single isolator and can be used to isolate multiple adjacent inverters.
- 10.4.3 Where micro inverters are not installed adjacent to each other, additional isolators shall be installed.
- 10.4.4 Isolator enclosures shall be IP 55 rated. The CEC recommends IP 66.
- 10.4.5 All entry points (conduit and cable glands) to the isolator should be on the lower face of the enclosure.
- 10.4.6 A secondary shield should be installed to shelter the inverter AC isolator from direct exposure to rain and sun.

10.5 AC cable selection

- 10.5.1 AC cables shall comply with the wiring requirements of AS/NZS3000:2018 Section 3 - Selection and installation of wiring systems.
- 10.5.2 Wiring systems concealed in walls but near the surface of a building require protection from mechanical damage as per AS/NZS3000:2018 clause 3.9.4.
- RCDs are one possible method for protecting inverter circuits. Section 10.6.5 of these Guidelines shall be followed for the selection of RCDs.
 - Where an inverter manufacturer cannot recommend a compliant RCD, another cable protection measure shall be used as per AS/NZS3000:2018 clause 3.9.4.4.
- 10.5.3 The overall voltage rise from the point of supply to the inverter AC terminals shall not exceed 2% of the nominal voltage at the point of supply. Individual states and territories may have their own specific requirements regarding cable selection and voltage rise. The installer shall ensure these are also complied with.
- It is recommended that the voltage drop between the inverter and the main switchboard should be kept as small as possible (recommended <1%) to minimise voltage rise within the installation. See table below).

NOTE: This will limit inverter disconnection in areas where the grid voltage may be too high to decrease incidents of overvoltage trips for inverters. This is also an issue for micro inverter installations where the AC cable run may be long.

**TABLE 1
MAXIMUM CABLE LENGTHS FOR 1% VOLTAGE RISE**

Inverter configuration		Single phase	Three phase	Three phase
Inverter rating (kVA)		5	5	10
Conductor current (A)		21.7	7.2	14.5
Cable conductor size (mm ²)	Conductor material	Maximum route length (m)	Maximum route length (m)	Maximum route length (m)
6	Cu	14	85	42
10	Cu	24	143	71
16	Cu	38	227	113
25	Cu	59	357	179

- 10.5.4 The inverter shall be connected by fixed wiring to a dedicated circuit on a switchboard.
- 10.5.5 AC cables between the inverter and any switchboard including all cables between any distribution board/s and the main switchboard which carry current from the inverter, shall be rated for at least the full output current of the inverter energy system.
- 10.5.6 All cabling shall be sized in accordance with AS/NZS3000:2018 and AS/NZS3008.1.1:2017.

10.6 Main switch inverter supply in switchboard

- 10.6.1 The inverter should be connected directly to the main switchboard.
- 10.6.2 Where this is not possible or not desirable, the inverter energy system should be connected to the distribution board located physically nearest the inverter and the main switchboard. All intermediate distribution boards shall be appropriately labelled (see Section 15 for examples of signs).
- 10.6.3 Overcurrent protection shall be installed on the inverter circuit.
- 10.6.4 The main switch at the switchboard to which the inverter is connected shall be a lockable switch.
- 10.6.5 Inverter systems are electricity generation systems and in accordance with AS/NZS3000:2018 clause 7.3, are not considered final sub-circuits, therefore RCDs are not required on all inverter circuits. However, there may be times where solar installers install RCDs on inverter circuits to comply with AS/NZS3000:2018 clause 3.9.4.4.
RCDs may be used if the following conditions are met:

- RCDs shall be of the type specified in the inverter manufacturer’s installation instructions so long as Section 8.6.5.2 is met.
- RCDs shall not be used where the inverter manufacturer specifies an RCD that is not compliant with AS/NZS3000:2018.
- RCDs that require a single directional flow shall not be installed on inverter circuits. This is because power can flow in both directions on inverter circuits.
- RCDs shall disconnect all active conductors (including the neutral).
- RCDs shall not be installed on the line side of multimode inverters. If the neutral is broken at the RCD, the circuits in “back up mode” will not have an M.E.N. Other means of mechanical protection shall be selected if required by AS/NZS3000:2018.

NOTE: All transformerless inverters have some DC leakage on the AC output. This can affect the intended operation of RCDs. Any RCDs installed on the same circuit as an inverter must be compatible with the inverter’s output waveform, and the allowable injected DC current of the inverter. Different inverter manufactures may have different requirements.

- 10.6.6 Arrangements of multiple main switches at a main switchboard or distribution switchboard shall comply with Table 2:
- When three-phase inverters are connected to a three-phase supply connection, a single three-pole main switch shall be installed.
 - IES 5kVA or below, main switches shall be grouped.
- 10.6.7 For inverter energy systems (IES) on different switchboards, refer to AS/NZS4777.1:2017 clause 5.5.4. Please refer to table 2 below.

**TABLE 2
ARRANGEMENTS OF MAIN SWITCHES**

Maximum rating of IES	Single-phase supply connection	Two-phase supply connection	Three-phase supply connection	Three-phase supply connection
Type of inverter	Single-phase	Single or two-phase	Single-phase	Three-phase
IES ≤5 kVA	Grouped	Grouped Where number of IES is >2, a two-pole main switch shall be installed. Inverter outputs should be balanced across phases.	Grouped Where number of IES is >2, a three-pole main switch should be installed. Inverter outputs should be balanced across phases.	Single three-pole main switch
5 <IES ≤30 kVA	Not permitted	Two-pole main switches shall be installed. Where number of main switches required >2 on a switchboard, then a single Main Switch (Inverter Supply) with its own distribution switchboard.	Three-phase main switches should be installed. Where number of main switches required >2 on a switchboard, then a single Main Switch (Inverter Supply) with its own distribution switchboard should be used.	Single three-pole main switch
30 <IES ≤200 kVA	Not permitted	Not permitted	Where inverters are co-located use distribution and single Submain Switches (Inverter Supply). Where inverters are not co-located, minimize the number of isolation points for safe isolation.	Single three-pole main switch

NOTE: All single-phase inverters connected to three-phase supply are to be balanced across phases and isolated in groups of three by operation of three-pole isolators.

10.7 Shutdown procedure

A shutdown procedure is required to ensure safe de-energisation of the system.

- 10.7.1 The shutdown procedure shall reflect the specific requirements of the individual system. All isolating switches referred to in the shutdown procedure shall correspond to individual isolator labels (e.g. “PV array DC isolator”, “Main Switch Inverter Supply”)

10.7.2 For central inverter systems, an engraved label showing the shutdown procedure shall be installed adjacent to the inverter. An example shutdown procedure would be as follows:

- Turn off the main switch solar supply at the AC switchboard and then the AC isolator at the inverter (where installed). Then;
- Turn off the PV array isolator at the inverter.

WARNING: PV array DC isolators do not de-energise the PV array and array cabling (see below for example).

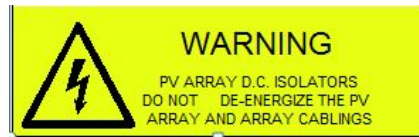

10.7.3 The shutdown procedure label for micro inverter and AC module systems shall be installed at the switchboard to which the system is connected.

An example shutdown procedure would be as follows:

- Turn off the “Main Switch Solar Supply” at the AC switchboard

This will isolate the PV array.

10.7.4 The shutdown procedure for DC conditioning units must reflect the specific requirements of the individual system.

NOTE: As this is different for the various technologies an example cannot be given.

10.8 Additional requirements for micro inverters

The following is in addition to the above requirements for all inverters:

- 10.8.1 Each input of the micro inverter is limited to 350W PV power at STC and at ELV.
- 10.8.2 DC cable length is less than 1.5 m (including any adaptor cables).
- 10.8.3 The method of cable support for the interconnecting AC cable and DC module cables shall have a life expectancy as long as the system.
- 10.8.4 Cable support shall ensure that there is no stress placed on connectors.
- 10.8.5 Wiring, plugs, sockets and connectors shall only be shall meet the requirements of Section 7.8
- 10.8.6 A PV array disconnection device is not required for PV modules connected to micro inverters (AS/NZS5033:2014 inc Amdt 1&2 clause 4.4.1.2).

NOTE: See section 7 for array earthing requirements for micro inverter systems.

10.9 Inverter earth fault indication

From 11 July 2015, AS/NZS5033:2014 required the installation of an earth fault alarm indication.

- 10.9.1 Where the PV array maximum voltage is greater than ELV an earth fault system shall be installed.
- 10.9.2 The alarm system may be an audible signal, indicator light or another form of fault communication (e.g. fax, email or SMS). The fault indication shall be installed in a way that it will make the system owner aware of the fault and initiate an action to correct an earth fault.
- 10.9.3 Micro inverter and AC module systems operate with a PV array maximum voltage in the ELV range and therefore are not required to have the earth fault indication, although the CEC recommends that if the system has the capability it should be installed.

- 10.9.4 Where the system utilises remote monitoring to inform the system owner of an earth fault, the configuration of the remote monitoring shall be provided in the system owner manual (see Section 5).

11 METERING

- 11.1.1 The installer shall notify the system owner of the metering processes. Refer to Section 3.1.3
11.1.2 The system shall not be energised until correct metering is installed, other than for testing or commissioning purposes as defined in Section 12.

NOTE: AS/NZS3000:2018 clause 7.3.3 states that the system may not be energised until a formal agreement has been made with the electricity distributor.

12 SIGNAGE

- 12.1.1 All signage on switches, isolators and within distribution boards and switchboards shall be in accordance with AS/NZS4777.1:2017 and AS/NZS5033:2014 inc amdt 1&2 and/or:
12.1.2 The relevant electrical service and installation rules for the state or territory where the system is installed.
12.1.3 Where multiple systems are installed at one premises, labelling shall accurately reflect which devices control which equipment.

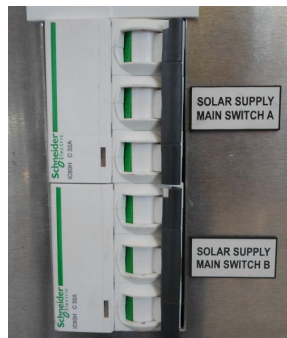

- 12.1.4 See Section 15 for examples of signs.

13 COMMISSIONING

- 13.1.1 The commissioning sheets provided with these Guidelines (or a similar document) shall be completed by the accredited installer or the accredited supervisor (with suitably licensed person).
13.1.2 A fully completed copy shall be provided to the system owner in the system documentation and a copy shall be retained by the Accredited Person.

NOTE: It is vitally important that a system is tested as per the commissioning requirements of this document to ensure it is safe at the time of final sign off. Additionally, it enables the installer to prove the system was correctly installed at the time of installation should any questions arise post installation.

14 INSTALLATION AND COMMISSIONING

14.1 General

WARNING: Where short circuit current measurements are required, follow AS/NZS5033:2014 inc amdt 1&2 Appendix D for the steps that shall be undertaken to measure the short circuit current safely.

NOTE: Some projects require that short circuit currents are recorded as part of the contractual commissioning; otherwise a record of the actual operating current of each string is sufficient. This could be done by using the meter on the inverter or by using a clamp meter when the system is operational.

14.2 Insulation resistance measurement

WARNING: PV array DC circuits are live during daylight and, unlike a conventional AC circuit, cannot be isolated before performing this test.

Follow AS/NZS:5033:2014 inc amdt 1&2 Appendix D4 for the steps that shall be undertaken to measure the insulation resistance safely.

Table 14.2.1 Minimum insulation resistance

System voltage ($V_{oc\ stc} \times 1.25$)	Test voltage	Minimum insulation resistance, M Ω
<120	250	0.5
120–500	500	1
>500	1000	1

14.3 String inverter installation and commissioning sample

INSTALLATION DETAILS			
Address of installation:			
PV module manufacturer and model number:			
Number of modules in series in a string:		Number of strings in parallel in PV array:	
Inverter manufacturer and model number:			
Number of inverters:		Number of MPPTs:	
PV ARRAY			
PV array tilt°		PV array orientation°	
Array frame is certified to AS1170.2:2011 for installation location <input type="checkbox"/>		Array frame is installed to manufacturer's instructions <input type="checkbox"/>	
No galvanically dissimilar metals are in contact with the array frames or supports <input type="checkbox"/>		Roof penetrations are suitably sealed and weatherproofed <input type="checkbox"/>	
PV wiring losses are less than 3% at the maximum current output of the array <input type="checkbox"/>		Where PV array comprises multiple strings- string protection has been provided if required. <input type="checkbox"/>	
Wiring is protected from mechanical damage and is appropriately supported <input type="checkbox"/>		Weatherproof PV array isolator mounted adjacent to the array <input type="checkbox"/> (Brand / Model:.....Rating:.....VDC,.....ADC)	
LV DC and AC INSTALLATION			
All low voltage wiring has been installed by a licensed electrical tradesperson <input type="checkbox"/>		All wiring has been tested and approved by qualified electrical tradesperson <input type="checkbox"/>	

INVERTER	
PV array isolator mounted adjacent to the inverter (Brand / Model:.....Rating:.....VDC,.....ADC) <input type="checkbox"/>	Isolator is mounted on output of the inverter (where required) <input type="checkbox"/>
Lockable AC circuit breaker mounted within the switchboard to act as the inverter main switch for the PV/inverter system (Rating A) <input type="checkbox"/>	Inverter is installed as per manufacturer's specification <input type="checkbox"/>
Inverter ceases supplying power within two seconds of a loss of AC mains <input type="checkbox"/>	Inverter does not resume supplying power until mains have been present for more than 60 seconds. The inverter shall not go straight to full power. It is required to ramp up from 0%-100% over a 6 minute period. <input type="checkbox"/>
CONTINUITY CHECK	
Circuit checked (record a description of the circuit checked in this column)	
Continuity of all string, sub-array and array cables	
Continuity of all earth connections (including module frame)	
SYSTEM CHECK	
WARNING:	
<ul style="list-style-type: none"> • IF A STRING IS REVERSED AND CONNECTED TO OTHERS, FIRE MAY RESULT. • IF POLARITY IS REVERSED AT THE INVERTER DAMAGE MAY OCCUR TO THE INVERTER. 	

	Polarity	Voltage	Short Circuit	Operating Current
String 1		V	A	A
String 2		V	A	A
String 3		V	A	A
String 4		V	A	A
Sub-arrays where required		V	A	A
PV array at PV array switch-disconnector		V	A	A
Calculated PV array maximum voltage	-	V	-	-
Irradiance at time of recording the current	-	-	W/m2	W/m2
INSULATION RESISTANCE MEASUREMENTS (see table 12.3.1 for minimum values of insulation resistance)				
Array positive to earth				MΩ
Array negative to earth				MΩ
Notes:				
CEC Accredited installer's name:				
CEC Accreditation number:				
I verify that the above system has been installed to all relevant standards				
Signed:				Date:
CEC Accredited Designer's name:				
Licensed electrician's name: (where applicable, e.g. LV work)				
Electrician's license number:				
Signed:				Date:

14.4 Micro inverter and AC module installation and commissioning sample

INSTALLATION DETAILS		
Address of installation:		
PV module manufacturer and model number:		
Number of modules in array:		
Inverter manufacturer and model number:		
Number of inverters:		
PV ARRAY		
PV array 1 tilt.....°	PV array 1 orientation.....°	Number of modules.....
PV array 2 tilt.....°	PV array 2 orientation.....°	Number of modules.....
PV array 3 tilt.....°	PV array 3 orientation.....°	Number of modules.....
PV array 4 tilt.....°	PV array 4 orientation.....°	Number of modules.....
Array frame is certified to AS1170.2:2011 for installation location <input type="checkbox"/>		Array frame is installed to manufacturer's instructions <input type="checkbox"/>
Wiring is protected from mechanical damage and is appropriately supported <input type="checkbox"/>		No galvanically dissimilar metals are in contact with the array frames or supports <input type="checkbox"/>
Roof penetrations are suitably sealed and weatherproofed <input type="checkbox"/>		
LV DC and AC INSTALLATION		
All low voltage wiring has been installed by a licensed electrical tradesperson <input type="checkbox"/>		All wiring has been tested and approved by qualified electrical tradesperson <input type="checkbox"/>

INVERTER	
AC isolator mounted adjacent to each group of micro inverters <input type="checkbox"/> (Rating:.....VDC,ADC)	Inverter communications device has been installed inverter (where required) <input type="checkbox"/>
Lockable AC circuit breaker mounted within the switchboard to act as the inverter main switch for the PV/inverter system (Rating A) <input type="checkbox"/>	Inverter is installed as per manufacturer's specification <input type="checkbox"/>
Inverter ceases supplying power within two seconds of a loss of AC mains <input type="checkbox"/>	Inverter does not resume supplying power until mains have been present for more than 60 seconds. <input type="checkbox"/>
CONTINUITY CHECK	
Circuit checked (record a description of the circuit checked in this column)	
SYSTEM CHECK (may need to be verified through the system communications portal)	
WARNING:	
<ul style="list-style-type: none"> IF POLARITY IS REVERSED AT THE INVERTER DAMAGE MAY OCCUR TO THE INVERTER. 	

	Polarity	Operating Voltage	Operating Current		Polarity	Operating Voltage	Operating Current
Module 1		V	A	Module 11		V	A
Module 2		V	A	Module 12		V	A
Module 3		V	A	Module 13		V	A
Module 4		V	A	Module 14		V	A
Module 5		V	A	Module 15		V	A
Module 6		V	A	Module 16		V	A
Module 7		V	A	Module 17		V	A
Module 8		V	A	Module 18		V	A
Module 9		V	A	Module 19		V	A
Module 10		V	A	Module 20		V	A







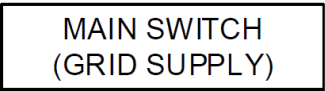
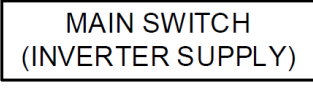
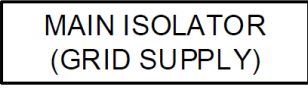

Irradiance at time of recording the current		W/m ²
---	--	------------------

Notes:

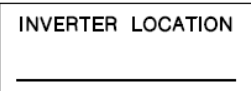

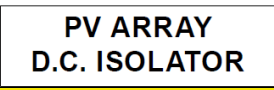

INSTALLER INFORMATION	
CEC Accredited installer's name:	
CEC Accreditation number:	
I verify that the above system has been installed to all relevant standards	
Signed:	Date:
CEC Accredited Designer's name:	
Licensed electrician's name: (where applicable, e.g. LV work)	
Electrician's licence number:	
Signed:	Date:

15 EXAMPLES OF SIGNAGE

15.1 String inverter systems

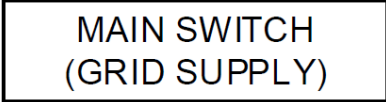
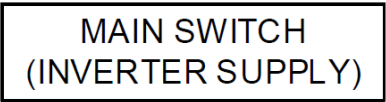
String Inverters: SIGNAGE (AS 4777.1:2017)	
	On switchboard to which inverter is directly connected <input type="checkbox"/>
	Is permanently fixed at the main switch <input type="checkbox"/>
	Is permanently fixed at the inverter supply main switch <input type="checkbox"/>
	Is permanently fixed adjacent to the isolator for the grid supply to the distribution <input type="checkbox"/>
	If the solar system is connected to a distribution board, then the following sign is located on main switchboard and all intermediate distribution boards <input type="checkbox"/>
	Where the inverter is not adjacent to the main switchboard, location information is provided <input type="checkbox"/>
SIGNAGE (AS/NZS5033:2014 inc amdt 1&2)	
	Is permanently fixed on array junction boxes (black on yellow) <input type="checkbox"/>
	Fire emergency information is permanently fixed on the main switchboard and/or meter box (if not installed together)(Voc = PV array maximum Voltage AS/NZS5033:2014 Cl4.2) <input type="checkbox"/>
	PV DC isolation is clearly identified <input type="checkbox"/>
	Is placed adjacent to the inverter when multiple isolation/disconnection devices are used that are not ganged together <input type="checkbox"/>
	Placed with shutdown procedure
Shutdown procedure is permanently fixed at inverter and/or on main switchboard <input type="checkbox"/>	Exterior surface of wiring enclosures labelled 'SOLAR' at 2 m intervals <input type="checkbox"/>
	Any other signage as required by the local electricity distributor <input type="checkbox"/>

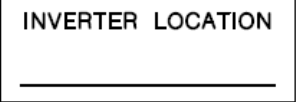
15.2 Micro inverter systems

Micro Inverters	
	On switchboard to which inverter is directly connected <input type="checkbox"/>
	Is permanently fixed at the main switch grid supply <input type="checkbox"/>
	Is permanently fixed at the inverter supply main switch <input type="checkbox"/>
	If the solar system is connected to a distribution board then the following sign is located on main switchboard and all intermediate distribution boards <input type="checkbox"/>
	Installed on all roof top AC isolators <input type="checkbox"/>
	This sign is required to notify other people that inverters are installed on site and where they are located (e.g. on roof) <input type="checkbox"/>
SIGNAGE (AS/NZS5033:2014 inc amdt 1&2)	
	Fire emergency information is permanently fixed on the main switchboard and the meter box (if not installed together) <input type="checkbox"/>
Shutdown procedure is permanently fixed at inverter and/or on main switchboard <input type="checkbox"/>	Any other signage as required by the local electricity distributor <input type="checkbox"/>

15.3 Example of 1 X string, 1 X inverter IES connected to sub board

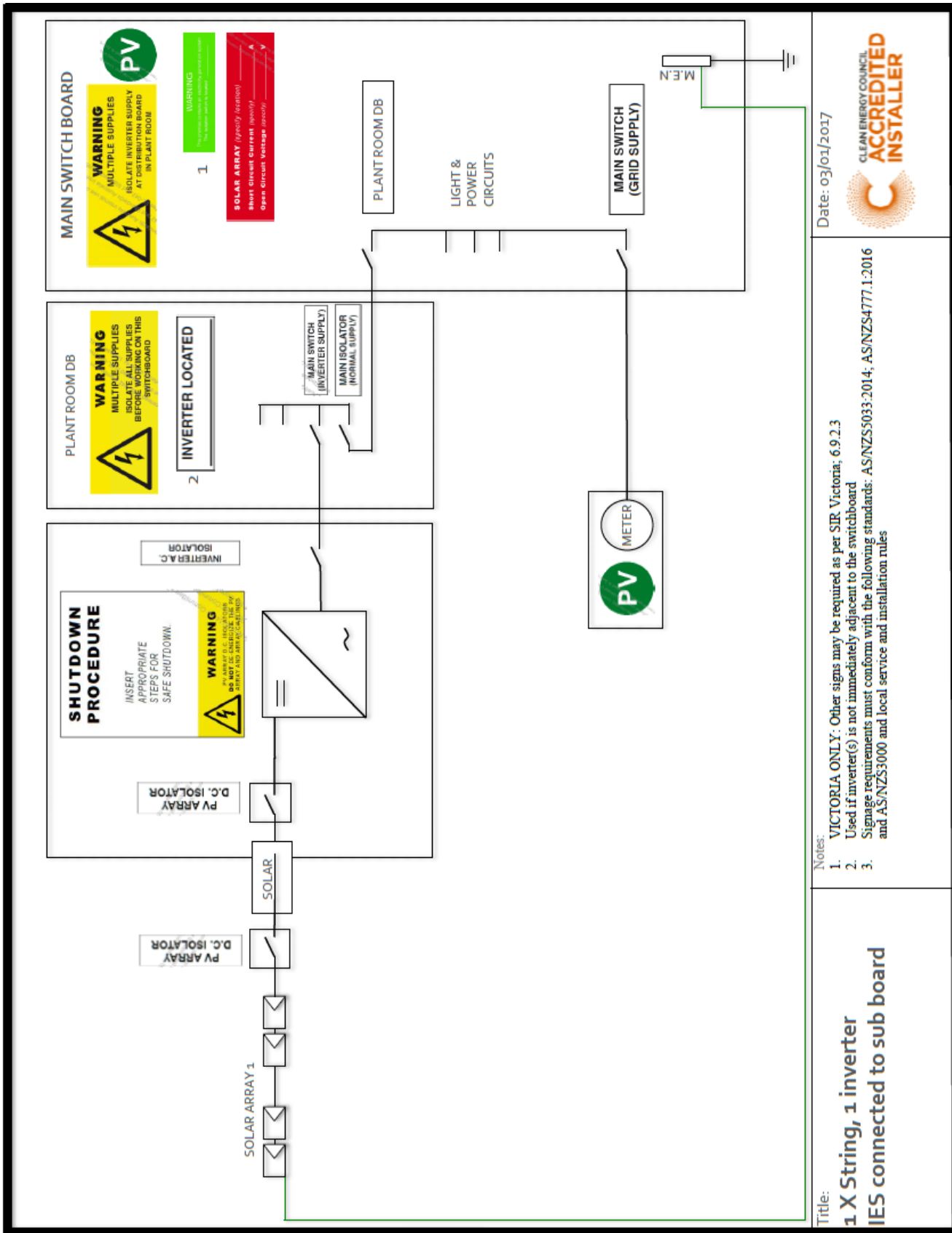

Date: 03/01/2017



Notes:
 1. VICTORIA ONLY: Other signs may be required as per SIR Victoria; 6.9.2.3
 2. Used if inverter(s) is not immediately adjacent to the switchboard
 3. Signage requirements must conform with the following standards: AS/NZS5033:2014; AS/NZS4777.1:2016 and AS/NZS3000 and local service and installation rules

Title:
1 X String, 1 inverter IES connected to sub board

15.4 Example of 1 X inverter, 2 X arrays IES connected to main board

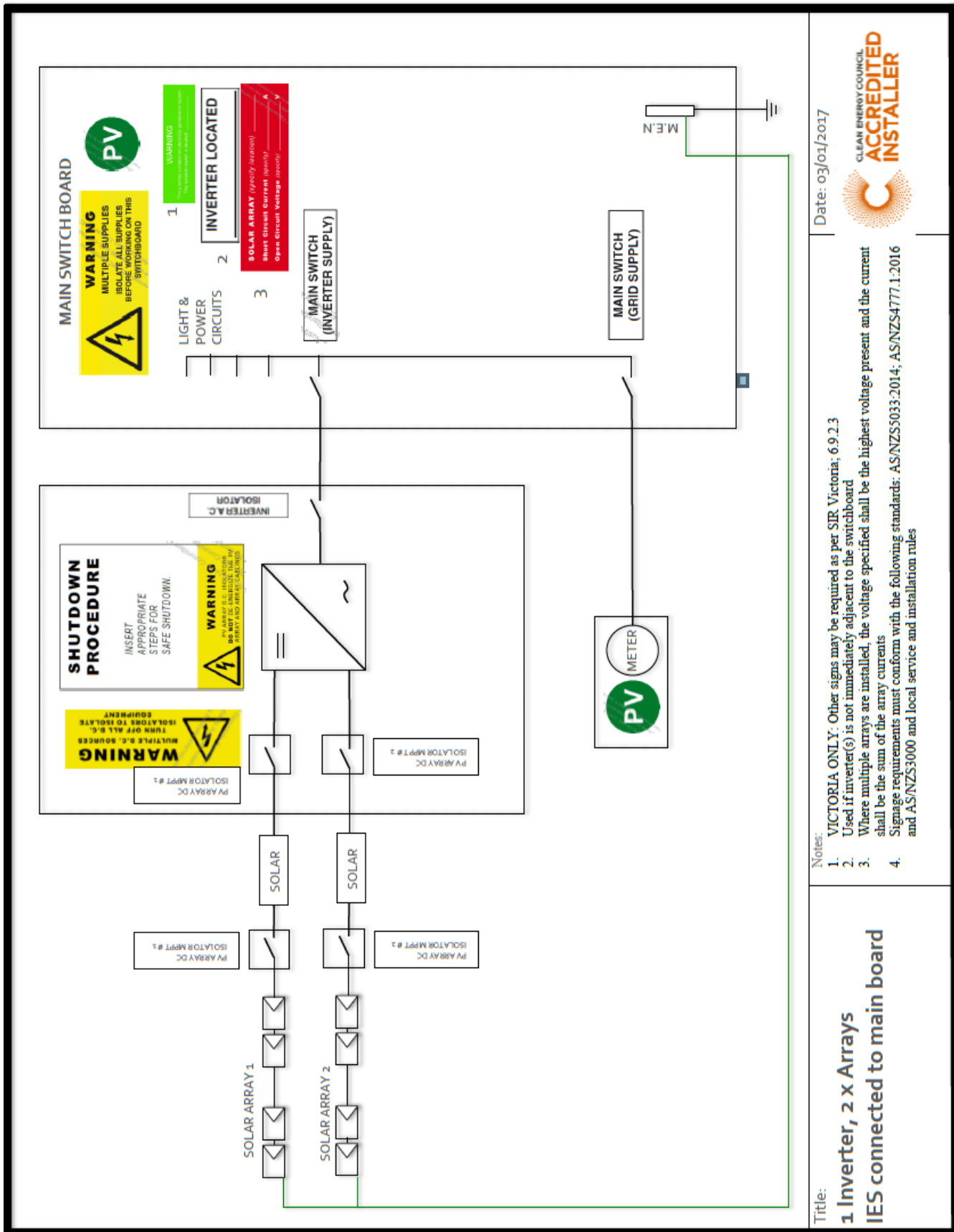

15.5 Example of 2 X string inverters IES connected to marshalling board

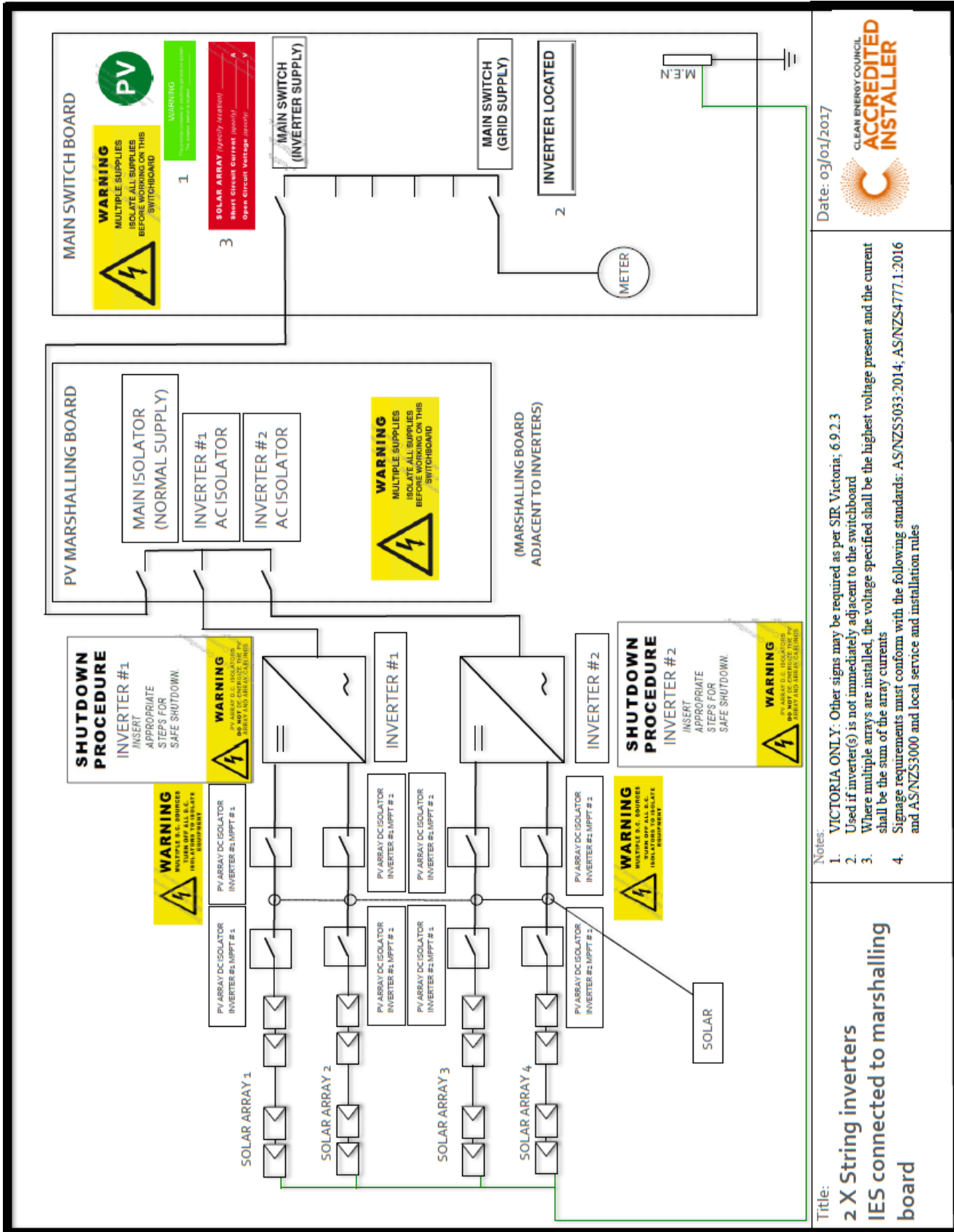

15.6 Example of Micro inverters connected to main board

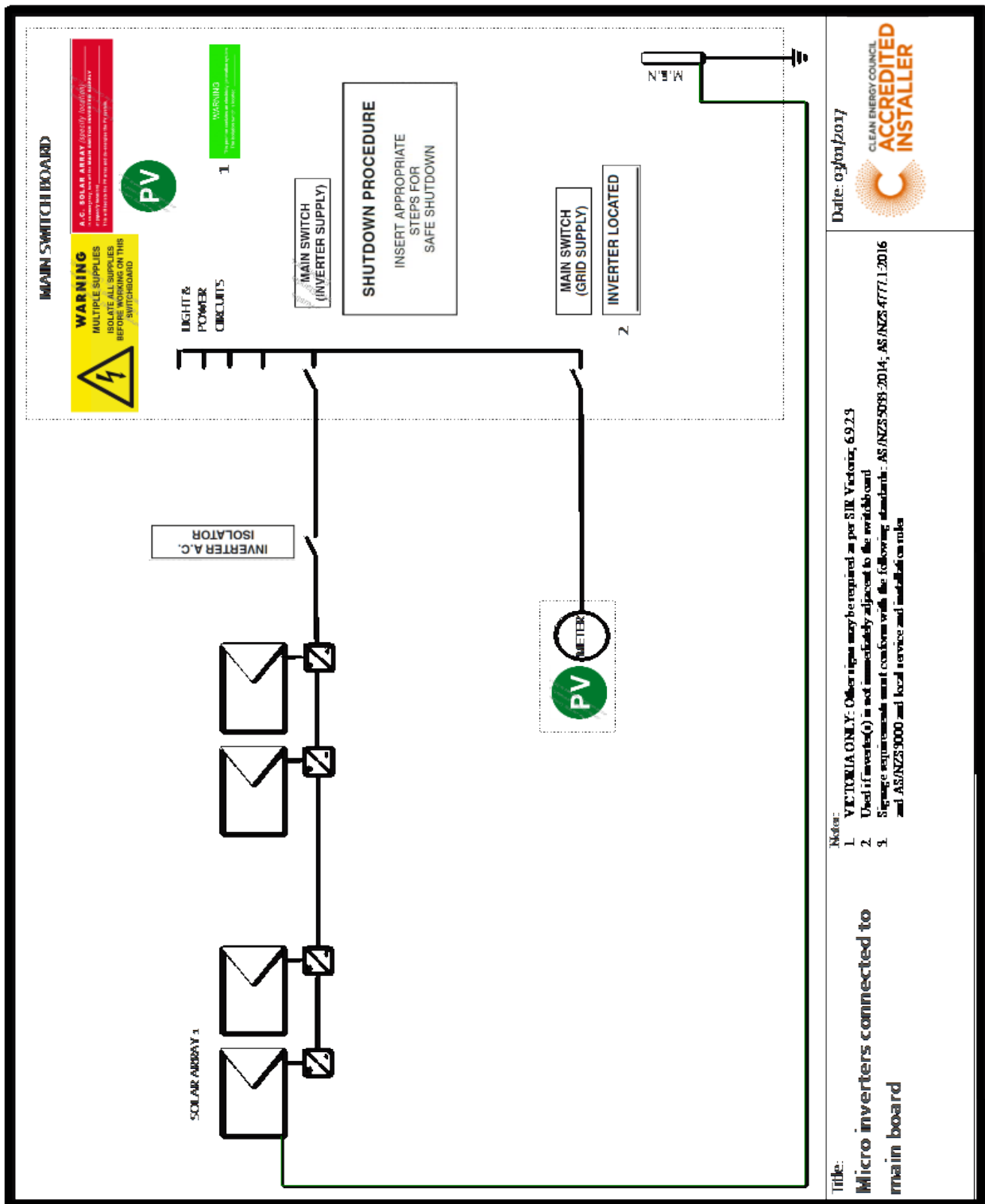

Title:
Micro inverters connected to
main board

Author:
1. VICTORIA ONLY: Other signs may be required as per SIR Victoria, 6.9.2.9
2. Used if inverte(s) is not immediately adjacent to the switchboard
3. Signage requirements must conform with the following standards: AS/NZS 5089:2014, AS/NZS 4771:2016
and AS/NZS 3000 and local service and installation rules

DATE: 03/04/2017

**CLEAN ENERGY COUNCIL
ACCREDITED
INSTALLER**

16 ATTACHMENT 1: DANGEROUS SITUATION

A dangerous situation can occur if the person installing the system comes into contact with the positive and negative outputs of the solar array or sub-array when the output voltage is 120V DC or above. Most grid-connected systems use approved solar modules which are connected using double insulated leads with polarised shrouded plug and socket connections.

A dangerous situation is only likely to occur at:

- the PV array isolator before the inverter
- the roof-top isolator
- the sub-array and array junction boxes (if used).

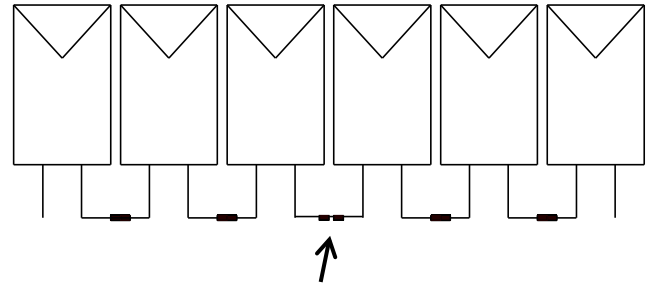

To prevent the possibility of an installer coming into contact with live wires, it is recommended practice that one of the interconnect cables in each string (as shown above) is left disconnected until all the wiring is completed between the array and the inverter. Only after all isolators and other hard-wired connections are completed, should the interconnection in the middle of the array be connected.

17 ATTACHMENT 2: PV ARRAY ROOF MOUNTING

Refer to AS/NZS 1170.2:2011 Structural design actions – Wind actions (and Australian Wind Regions map, below.)

PV array frames shall be wind rated for the site. Consult the manufacturer's specifications (some modules are not suitable for use in cyclone zones).

Care shall be taken with roof fixing systems. Consideration shall be given to factors such as:

- wind direction
- terrain category (suburban, city/industrial)
- location topography
- height of structure.

As an example, where the PV array is within 1 metre of roof edges, wind loading can be doubled. Additional fixing may be required based on the wind region. Wind regions C and D below are cyclonic areas and have special roof and PV module attachment requirements. Consult the PV module structural and mounting specifications for high wind areas.

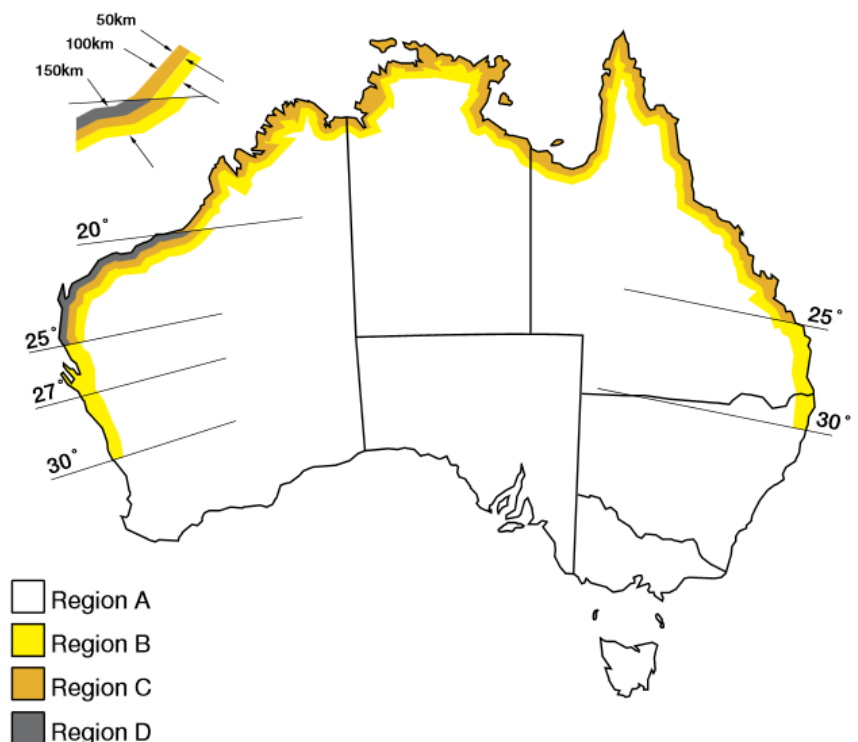

Image: Sunlock

18 ATTACHMENT 3: WH&S INFORMATION

The CEC is not a safety regulator and cannot advise on high-risk work such as:

- working at heights where a person has a risk of falling more than two metres; and
- on or near energised electrical installations or services.

Across Australia, each state and territory has different definitions and requirements for their obligations towards WH&S. If you need help, please contact your state or territory work health and safety authority;



WorkSafe Victoria - <https://www.worksafe.vic.gov.au>



WorkSafe Tasmania - <https://www.worksafe.tas.gov.au>



SafeWork SA - <https://www.safework.sa.gov.au>



WorkSafe WA - <https://www.commerce.wa.gov.au/worksafe>



NT WorkSafe - <http://www.worksafe.nt.gov.au>



Workplace Health and Safety Queensland - <https://www.worksafe.qld.gov.au>



SafeWork NSW - <https://www.safework.nsw.gov.au>



WorkSafe ACT- <https://www.accesscanberra.act.gov.au/app/home/workhealthandsafety>